



Katalog 2017



Felo Werkzeugfabrik
Holland-Letz GmbH
Emil-Rössler-Straße 59
D - 35279 Neustadt (Hessen)

Tel.: ++49 (0) 66 92 - 88 0
Fax: ++49 (0) 66 92 - 88 99
Email: info@felo.com
www.felo.com



67

years of Felo! Our customers and employees are proud of this anniversary. In 1950 Felo Werkzeugfabrik was founded in Neustadt (Hessen). Driven by innovative power, quality consciousness and enthusiasm the company grew from humble beginnings with two employees into one of the leading manufacturers of screwdrivers and bits. Today 200 people work for Felo.

67 Jahre Felo! Ein Jubiläum auf das unsere Mitarbeiter und Kunden stolz sind! Die Felo-Werkzeugfabrik wurde 1950 in Neustadt (Hessen) gegründet. Aus bescheidenen Anfängen mit 2 Angestellten entstand durch Innovationskraft, Qualitätsbewusstsein und Begeisterung einer der weltweit führenden Hersteller von Schraubendrehern und Bits. Heute arbeiten 200 Mitarbeiter für Felo.



2000

stocked items are at the daily disposal of our customers. On top of this we manufacture the same number of products in customized versions, as special tools and under private brand.

2000 Artikel stehen unseren Kunden täglich ab Lager zur Verfügung. Zusätzlich fertigen wir etwa die gleiche Anzahl von Produkten in Sonderausführungen, als speziell entwickelte Problemlösungen oder unter Kunden-Marken.

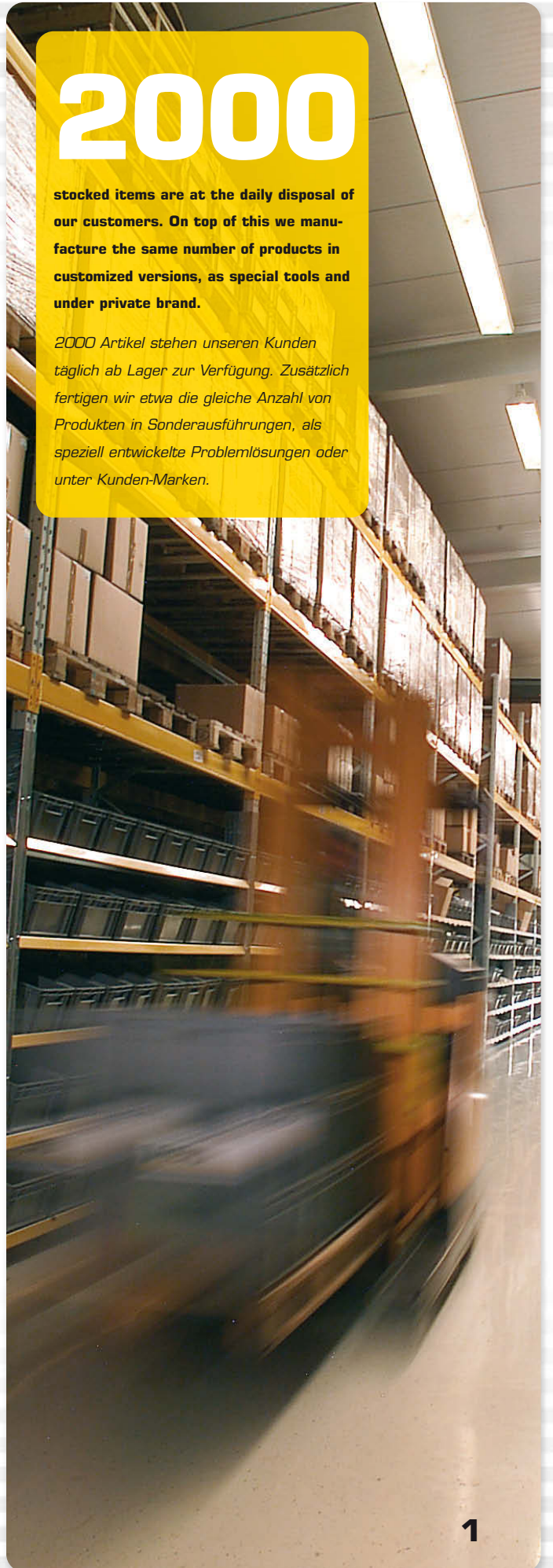

139

years of experience in the development, production and marketing of screwdrivers. In 1878 the »Hammermühle« factory for tools was founded. The product range included forged screwdrivers as well as chisels, hammers and pliers. The foundation of Felo in 1950 was based on this company.

139 Jahre Erfahrung in der Entwicklung und Herstellung von Schraubwerkzeugen. 1878 wurde in Thüringen die Werkzeugfabrik »Hammermühle« gegründet. Das Sortiment umfasste geschmiedete Schraubendreher, sowie Meißel, Hämmer und Zangen. Aus diesem Unternehmen ging 1950 Felo-Werkzeugfabrik hervor.



40

Felo tools are exported to 40 countries: we are a global player and specialist, offering a wide variety of products for the most different markets and requirements. Felo is traditionally strong in exports: almost 100 years ago we began using catalogues in 4 languages. Since then Felo has become a byword for quality.

40 Länder in die Felo Werkzeuge exportiert werden: wir sind ein weltweit tätiges Unternehmen, das als Spezialist eine große Programmtiefe anbietet und sich damit auf unterschiedlichste Märkte und Bedürfnisse einstellen kann.

Traditionell exportstark: bereits vor fast 100 Jahren verwendeten wir die ersten viersprachigen Kataloge. Seitdem wird Felo Werkzeug in vielen Teilen der Welt als Inbegriff von Qualität geschätzt.



260

applications for industrial property rights document our innovative power!

Progressive ideas like 2-component handles, Titanium-coated bits and screwdrivers with exchangeable blades for electricians originated from Felo developments. Our curiosity and creativity have made us a leader in product and production.

260 Schutzrechtsanmeldungen dokumentieren unsere Innovationskraft! Wichtige Fortschritte, wie der 2-Komponentengriff, TiN Bits oder Wechselklingen-Systeme für Elektriker gehen auf Entwicklungen von Felo zurück. Unsere Neugier und Kreativität haben uns in den Bereichen Produkt und Produktion zu einem der weltweit führenden Hersteller werden lassen.



1

mission:



























We want to inspire our customers! This doesn't just show in our products but also in our flexibility, customer service, reliability and cost-efficiency. Test for yourself our strengths!





























1 Ziel:

Wir wollen unsere Kunden begeistern! Dies spiegelt sich nicht nur in den Felo Produkten wider, es zeigt sich auch bei Flexibilität, Service, Zuverlässigkeit und Kosteneffizienz.

Überzeugen auch Sie sich von unseren Stärken!



										
	Series 400 Pg/S. 6 - 19	Series 550 Pg/S. 20 - 23	Series 500 Pg/S. 24 - 35	Series 206 Pg/S. 36 - 37	Series 200 Pg/S. 38 - 43	Series 330/ Series 490 Pg/S. 44 - 47	VDE/ Insulated Pg/S. 48 - 75	Series Nm Pg/S. 76 - 81	Series 240/ 250 ESD/ 280 Pg/S. 82 - 87	
for slotted screws <i>Schlitzschrauben</i>		8-10, 13-17, 19	21-23	25-35	37	39-43	45-47	49-51, 53, 55-56, 59-70, 74-75	77-78, 80-81	83, 85-87
PZ Pozidriv-Superdriv		8-10, 14-16	21	25-26, 29, 31-35	37	39, 42, 43	45-46	49-51, 53, 56, 59, 61-67, 74	77-78, 80-81	83, 86
PH Phillips		8-9, 11, 13-17, 19	21-23	25-26, 28-29, 31-35	37	39-43	45-46	49-51, 53, 55-56, 61-68, 74-75	77-78, 80-81	83, 85-87
+ / - Plus - Minus								50-51, 54	80-81	
Torx® Torx®		11, 14, 17-18		27-28, 31-33		40, 41		49, 51, 54	77-78, 80	84
Torx® TR Torx® Tamper Resistant		11		26, 34						
Torx Plus® IP				27					77-78, 80	
Inner Hexagon Innensechskant				30					80	84
Nut Drivers Steckschlüssel		12, 19		30			46	57		84-85
SQ Square for Robertson® screws		11, 17						54		
XZN XZN										
Clutch										
Spanner								50		
TS for TorqSet® screws										
Tri-Wing®										
LocTec®										
Bitholder/ Bithalter		12-13		29-30				50, 63	77-78, 80	86

 Series 370 Pg/S. 88 - 89	 T-Handles/ Series 340 Pg/S. 90 - 93	 Hex & Torx L-Keys & Flagdrivers Pg/S. 94 - 101	 R-GO XS Pg/S. 102 - 113	 smart E/smart Pg/S. 114 - 123	 Impact Torsion Challenger TiN Industrial Pg/S. 124 - 151	 Bit-Sets Pg/S. 152 - 171	 Special-Bits Adapters Bitholders Pg/S. 172 - 181	 Pliers Pg/S. 182 - 189	 Displays Pg/S. 190 - 209	
89	93		103, 105-106, 109-111	115-117, 119, 121-123	125, 130, 132, 136, 141, 143-144, 147-148	153-155, 157, 160-161, 163, 165-171	172-181		191-205	
89	93		103, 105-106, 109-110	115-117, 119, 121-123	125-127, 129-132, 134-137, 141, 143-148, 150-151	153-171	175		191, 193-205	
89	93		103, 105-106, 109-111	115-117, 119, 121-123	125-127, 129-137, 141, 143-147, 149-151	153-171	174-175, 177		191-205	
				121-123	144					 
89	92	95-97	103, 105-106, 110	115-117, 119, 121-123	125-127, 129, 131, 133-134, 138, 142-147, 149-151	153-154, 156-162, 164-166, 169-171	176-177		191, 197-198, 200-202, 204-205	
			110	119	139	171				
		95-96			139, 141					
	91-93	98-101	103, 105-106, 110	115-117, 119	138, 142, 149	160-161, 171	174, 176		205	
	91		103-107, 110, 111, 113	115-119	149	170	173			
			105-106, 111	119, 123	138, 142-143	160				
				119	140	171	176			
					139	171				
			105-106, 111	121	140	160, 171				
					140	171				
					140	171				
							172			
89	92		103, 105-106, 109-112	115-117, 119, 123	149, 151	146-157, 159, 163-165	177-180		204-206	

Ergonic, the first handle that adapts to the users hand!

Ergonic, der erste Griff, der sich der Hand anpasst!



smooth, seamless handle for maximum comfort

nahtfrei glatte Kappe für minimale Reibung

hand and handle interlock, causing less strain

Hand und Griff verzahnen sich – der Kraftaufwand sinkt

Serie 400 **ERGONIC**® (pat.)

EP 1963072

stronger / stärker
adaptable / anpassungsfähig
truly ergonomic / wirklich ergonomisch

hexagon bolsters available on series 410

Sechskant-Schlüsselhilfe bei Serie 410

blades manufactured from chrome-molybdenum-vanadium steel

Klingen aus spezieller Chrom-Molybdän-Vanadium-Legierung

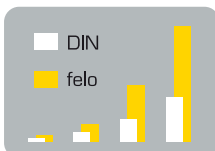

superior torque which exceeds DIN and ISO requirements by up to 100%

Beste Leistungsdaten, bis zu 100% über DIN-Werten

anti-roll handle design

Griffkopf mit Abrollschutz

hanging hole for easy storage or inserting lever

Querloch: Zum Aufhängen der Werkzeuge oder zum Einstecken eines Hebels

screw symbols on handle cap

Schraubensymbole auf Griffkappe



full length, impact proof handle core

durchgehender, schlagfester Hartkern



GS tested for safety

GS – geprüfte Sicherheit



EAN code on every product

EAN-Code auf jedem Werkzeug



black tip for precision fit

Black-Tip zur Erhaltung der Präzision und Passgenauigkeit



There are numerous ergonomic handle designs: It is always the user's hand that has to adjust to the handle. ERGONIC is the only handle adjusting to the individual hand!

Es gibt viele ergonomische Griffe: Immer ist es die Hand, die sich an den Griff anpassen muss. ERGONIC ist der einzige Griff, der sich jeder Anwenderhand anpasst!

The new standard in ergonomics, torque transmission and responsiveness!

Der neue Maßstab für Ergonomie, Kraftübertragung und Feinfühligkeit!

ERGONIC®

The impact proof handle core is coated with elastic, scratch resistant elastomer containing cells of highly flexible plastics.

Der Griffkern aus schlagfestem Hartkunststoff ist mit einem widerstandsfähigen elastischen Griffkörper ummantelt, in den Polster aus hochflexiblem Kunststoff eingelassen sind.



The handle fits perfectly into the hand at all times. Hand and handle interlock, causing less strain and work fatigue, allowing higher maximum torque! Responsiveness of material results in enhanced sensitivity and perfect control of torque.

Der Griff füllt die Hand immer optimal aus: Hand und Griff verzahnen sich – der Kraftaufwand sinkt! Dadurch werden höhere Drehmomente und längeres ermüdungsfreies Arbeiten möglich. Die Flexibilität des Materials erhöht zusätzlich die Feinfühligkeit und ermöglicht den präzisen Krafteinsatz.

felo
INNOVATIONEN



410



								Item No		EAN-Code
4,0 x 0,8	75	94	30	4,0	12		410 042 40	47	40 07157 53121 6	
5,5 x 1,0	100	101	33	5,0	12		410 553 40	88	40 07157 52785 1	
6,5 x 1,2	125	106	36	6,35	12		410 654 40	113	40 07157 52787 5	
8,0 x 1,2	150	112	39	8,0	12		410 085 40	167	40 07157 52789 9	
10,0 x 1,6	175	112	39	8,0	6		410 105 40	177	40 07157 53125 4	
12,0 x 2,0	200	112	39	10,0	6		410 127 40	253	40 07157 53127 8	



411



PZ						Item No		EAN-Code
1	80	94	30	5,0	12	411 102 40	60	40 07157 52791 2
2	100	106	36	6,35	12	411 203 40	106	40 07157 52793 6
3	150	112	39	8,0	6	411 305 40	172	40 07157 53129 2



412



PH						Item No		EAN-Code
1	80	94	30	5,0	12	412 102 40	60	40 07157 52795 0
2	100	106	36	6,35	12	412 203 40	105	40 07157 52797 4
3	150	112	39	8,0	6	412 305 40	169	40 07157 53131 5
4	150	112	39	10,0	6	412 405 40	228	40 07157 63079 7



410



	Item No		EAN-Code
Set 6-pcs / Satz 6-tlg.	410 961 48	538	40 07157 53167 4
(4 x) 400 - 410: 3,0 x 80 / 4,0 x 75 / 5,5 x 100 / 6,5 x 125			
(2 x) 412: PH 1 x 80 / PH 2 x 100			

410



	Item No		EAN-Code
Set 6-pcs / Satz 6-tlg.	410 962 48	542	40 07157 53513 9
(1 x) 400: 3,0 x 80			
(3 x) 410: 4,0 x 75 / 5,5 x 100 / 6,5 x 125			
(2 x) 411: PZ 1 x 80 / PZ 2 x 100			

410



	Item No		EAN-Code
Set 6-pcs / Satz 6-tlg.	410 963 48	630	40 07157 53673 0
(2 x) 410: 5,5 x 100 / 6,5 x 125			
(2 x) 411: PZ 1 x 80 / PZ 2 x 100			
(2 x) 412: PH 1 x 80 / PH 2 x 100			

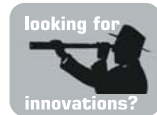

400



									Item No		EAN-Code
2,5 x 0,4	75	86	25	2,5	12				400 022 10	27	40 07157 53679 2
3,0 x 0,5	80	86	25	3,0	12				400 032 10	30	40 07157 53117 9
3,5 x 0,6	100	86	25	3,5	12				400 353 10	33	40 07157 53119 3
4,0 x 0,8	100	94	30	4,0	12				400 043 10	49	40 07157 53611 2
5,0 x 0,8	150	101	33	5,0	12				400 055 10	75	40 07157 53619 8
5,5 x 1,0	125	101	33	5,0	12				400 554 10	72	40 07157 53621 1
5,5 x 1,0	150	101	33	5,0	12				400 555 10	82	40 07157 53623 5
6,0 x 1,2	100	106	36	6,0	12				400 063 10	79	40 07157 57589 0
6,0 x 1,2	150	106	36	6,0	12				400 065 10	102	40 07157 57591 3
6,0 x 1,2	200	106	36	6,0	12				400 067 10	112	40 07157 57593 7
6,5 x 1,2	100	106	36	6,0	12				400 653 10	79	40 07157 53627 3
6,5 x 1,2	150	106	36	6,0	12				400 655 10	102	40 07157 52799 8
6,5 x 1,2	200	106	36	6,0	12				400 657 10	112	40 07157 53629 7
8,0 x 1,2	175	112	39	7,0	12				400 086 10	135	40 07157 52801 8
10,0 x 1,6	200	112	39	8,0	6				400 107 10	162	40 07157 53681 5

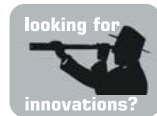

401



PZ									Item No		EAN-Code
1	80	94	30	4,5	12				401 102 10	50	40 07157 53683 9
2	100	106	36	6,0	12				401 203 10	92	40 07157 53685 3
3	150	112	39	8,0	6				401 305 10	148	40 07157 53687 7

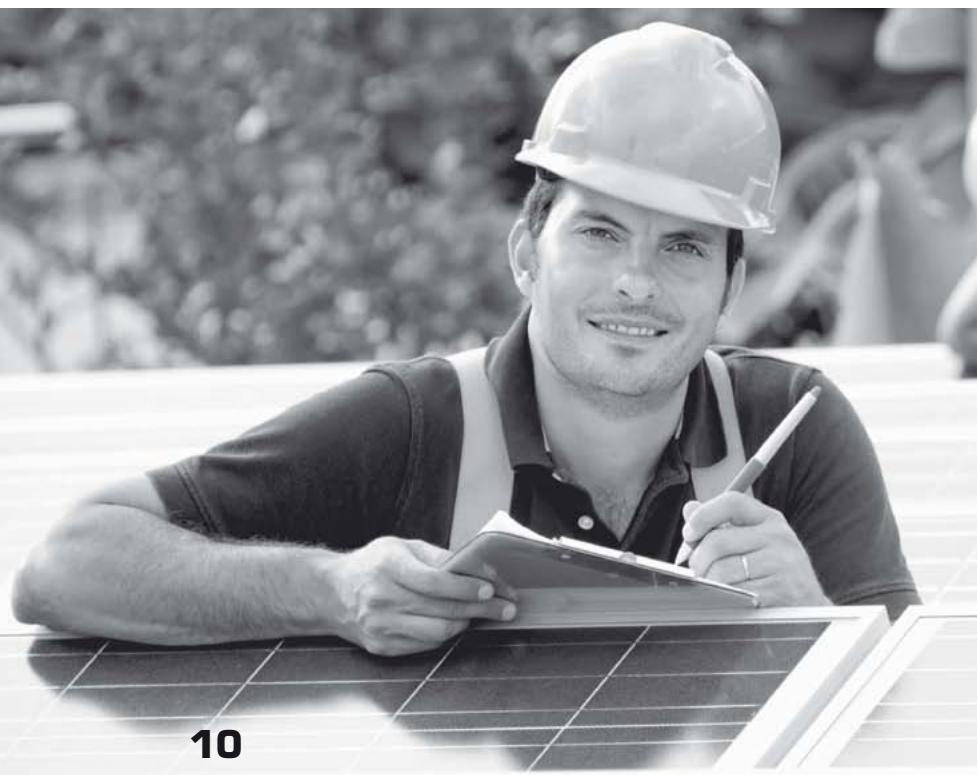

Professional users in particular appreciate the innovative features of our tools.

Professionelle Anwender wissen die innovativen Eigenschaften der Felo Werkzeuge zu schätzen.

402

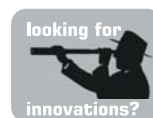

PH						Item No		EAN-Code
1	80	94	30	4,5	12	402 102 10	50	40 07157 52803 2
2	100	106	36	6,0	12	402 203 10	92	40 07157 52805 6
2	150	106	36	6,0	12	402 205 10	103	40 07157 53637 2
2	200	106	36	6,0	6	402 207 10	114	40 07157 53639 6
3	150	112	39	8,0	6	402 305 10	146	40 07157 53689 1

404

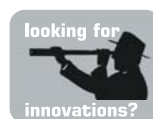

SQ						Item No		EAN-Code
0 (1,75 mm)	100	94	30	3,0	12	404 000 40	44	40 07157 60309 8
1 (2,30 mm)	120	94	30	4,5	12	404 100 40	56	40 07157 53507 8
2 (2,80 mm)	160	106	36	5,0	12	404 200 40	91	40 07157 53509 2
3 (3,30 mm)	160	106	36	6,0	12	404 300 40	105	40 07157 53511 5

408



Torx®						Item No		EAN-Code
7	60	86	25	3,0	12	408 071 40	28	40 07157 52807 0
8	60	86	25	3,0	12	408 083 40	28	40 07157 52809 4
9	60	86	25	3,5	12	408 093 40	28	40 07157 52811 7
10	100	86	25	3,5	12	408 103 40	33	40 07157 52813 1
15	100	94	30	4,0	12	408 153 40	50	40 07157 52815 5
20	100	101	33	5,0	12	408 203 40	68	40 07157 52817 9
25	100	106	36	5,0	12	408 253 40	82	40 07157 52819 3
27	100	106	36	5,0	12	408 273 40	82	40 07157 52821 6
30	115	112	39	6,0	6	408 303 40	103	40 07157 52823 0
40	125	112	39	8,0	6	408 404 40	136	40 07157 52825 4

407

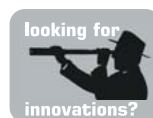

Torx®TR						Item No		EAN-Code
10	100	86	25	3,5	12	407 103 40	33	40 07157 60903 8
15	100	94	30	4,0	12	407 153 40	50	40 07157 60905 2
20	100	101	33	4,0	12	407 203 40	68	40 07157 60907 6
25	100	106	36	5,0	12	407 253 40	82	40 07157 60909 0

M-TEC

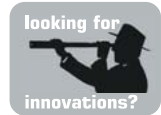
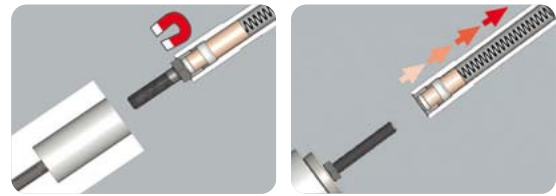

428



mm						Item No		EAN-Code
5,5	110	94	30	12	12	428 055 30	84	40 07157 60285 5
6	110	94	30	12	12	428 060 30	87	40 07157 60349 4
7	110	94	30	12	12	428 070 30	97	40 07157 60287 9
8	110	101	33	12	12	428 080 30	110	40 07157 60289 3
10	125	101	33	12	12	428 100 30	126	40 07157 60291 6
13	125	106	36	12	12	428 130 30	187	40 07157 60293 0

flexible



429



mm						Item No		EAN-Code
5	170	106	36	6	6	429 050 40	148	40 07157 60355 5
6	170	106	36	6	6	429 060 40	148	40 07157 60357 9
7	170	106	36	6	6	429 070 40	148	40 07157 60359 3
8	170	106	36	6	6	429 080 40	151	40 07157 60361 6
10	170	106	36	6	6	429 100 40	151	40 07157 60363 0
1/4"	170	106	36	6	6	429 635 40	146	40 07157 60365 4



438

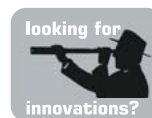

1/4" 100 101 33 6 **Item No** **438 125 40** **EAN-Code** 102 40 07157 53711 9

497

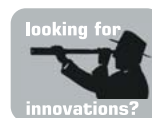

Adapter for sockets 1/4" / Adapter für Steckschlüsseinsätze 1/4"
100 101 33 6 **Item No** **497 110 40** **EAN-Code** 107 40 07157 61479 7

Stubby



Stubby
5,5 x 25 25 60 21 12 **Item No** **400 550 10** **EAN-Code** 36 40 07157 61509 1
PH 2 25 60 21 12 **Item No** **402 020 10** **EAN-Code** 38 40 07157 61511 4

Stubby



Stubby Bitholder 1/4" / Stubby Bithalter
18 62 25 12 **Item No** **438 026 40** **EAN-Code** 48 40 07157 61727 9

497









Bottle Opener / Flaschenöffner
94 30 12 **Item No** **497 200 00** **EAN-Code** 59 40 07157 62405 5



400









	Item No		EAN-Code
Ergonic XXL-Rack 17-pcs / Rack 17 tlg.	400 917 43	2332	40 07157 60391 3
(5 x) 400:	3,0 x 80 / 4,0 x 100 / 5,5 x 125 / 6,5 x 150 / 8,0 x 175		
(2 x) 401:	PZ 1 x 80 / PZ 2 x 100		
(2 x) 402:	PH 1 x 80 / PH 2 x 100		
(2 x) 413:	3,5 x 100 / 4,0 x 100    AC 1000V IEC 60900 : 2012		
(2 x) 414:	PH 1 x 80 / PH 2 x 100    AC 1000V IEC 60900 : 2012		
(4 x) 408:	Torx® 10 x 100 / Torx® 15 x 100 / Torx® 20 x 100 / Torx® 25 x 100		
(1 x)	Steel Rack / Werkzeuhalter (Stahl)		



400



	Item No		EAN-Code
Ergonic XL-Rack 10-pcs / Rack 10 tlg.	400 910 13	1296	40 07157 63633 1
(3 x) 400:	4,0 x 100 / 5,5 x 125 / 6,5 x 150		
(2 x) 402:	PH 1 x 80 / PH 2 x 100		
(1 x) 413:	3,5 x 100    AC 1000V IEC 60900 : 2012		
(3 x) 408:	Torx® 15 x 100 / Torx® 20 x 100 / Torx® 25 x 100		
(1 x) 361:	Mains testing screwdriver / Profi-Spannungsprüfer VDE 0680 150 V - 250 V		
(1 x)	Steel Rack / Werkzeuhalter (Stahl)		

	Item No		EAN-Code
Ergonic XL-Rack 10-pcs / Rack 10 tlg.	400 910 43	1296	40 07157 63635 5
(3 x) 400:	4,0 x 100 / 5,5 x 125 / 6,5 x 150		
(2 x) 401:	PZ 1 x 80 / PZ 2 x 100		
(1 x) 413:	3,5 x 100    AC 1000V IEC 60900 : 2012		
(3 x) 408:	Torx® 15 x 100 / Torx® 20 x 100 / Torx® 25 x 100		
(1 x) 361:	Mains testing screwdriver / Profi-Spannungsprüfer VDE 0680 150 V - 250 V		
(1 x)	Steel Rack / Werkzeuhalter (Stahl)		



400



	Item No		EAN-Code
Set 7-pcs / Satz 7-tlg.	400 971 18	602	40 07157 53695 2
(4 x) 400:	3,5 x 100 / 4,0 x 100 / 5,5 x 125 / 6,5 x 150		
(1 x) 401:	PZ 2 x 100		
(2 x) 402:	PH 1 x 80 / PH 2 x 100		



400



	Item No		EAN-Code
toolcase 6-pcs / Koffer 6-tlg.	400 106 36	682	40 07157 62409 3
(2 x) 400:	4,0 x 100 / 6,5 x 100		
(2 x) 401:	PZ 1 x 80 / PZ 2 x 100		
(2 x) 402:	PH 1 x 80 / PH 2 x 100		



400



	Item No		EAN-Code
toolcase 6-pcs / Koffer 6-tlg.	400 206 36	652	40 07157 62411 6
(4 x) 400:	3,0 x 80 / 4,0 x 100 / 5,5 x 125 / 6,5 x 100		
(2 x) 402:	PH 1 x 80 / PH 2 x 100		



400



	Item No		EAN-Code
Set 6-pcs / Satz 6-tlg.	400 961 18	548	40 07157 53691 4
(2 x) 400:	4,0 x 100 / 6,5 x 150		
(2 x) 401:	PZ 1 x 80 / PZ 2 x 100		
(2 x) 402:	PH 1 x 80 / PH 2 x 100		

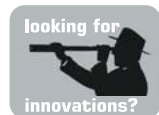

400



	Item No		EAN-Code
Set 5-pcs / Satz 5-tlg.	400 953 18	492	40 07157 57539 5
(3 x) 400:	4,0 x 100 / 5,5 x 125 / 6,5 x 150		
(2 x) 401:	PZ 1 x 80 / PZ 2 x 100		

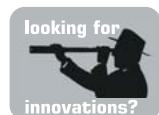

400



	Item No		EAN-Code
Set 5-pcs / Satz 5-tlg.	400 951 18	492	40 07157 53693 8
(3 x) 400:	4,0 x 100 / 5,5 x 125 / 6,5 x 150		
(2 x) 402:	PH 1 x 80 / PH 2 x 100		

400



Item No



EAN-Code

Set 3-pcs / Satz 3-tlg.

400 931 18

312

40 07157 53701 0

[2 x] 400: 5,5 x 125 / 6,5 x 150

[1 x] 402: PH 2 x 100

404



Item No



EAN-Code

Set 3-pcs / Satz 3-tlg.

404 931 48

269

40 07157 53517 7

[3 x] 404: SQ 1 / SQ 2 / SQ 3

400

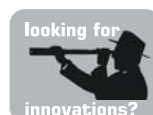

Item No



EAN-Code

Set 5-pcs / Satz 5-tlg.

401 951 48

442

40 07157 63351 4

[2 x] 401: PZ 1 x 80 / PZ 2 x 100

[3 x] 408: Torx® 15 / 20 / 25

400



Item No



EAN-Code

Set 5-pcs / Satz 5-tlg.

402 951 48

442

40 07157 63353 8

[2 x] 402: PH 1 x 80 / PH 2 x 100

[3 x] 408: Torx® 15 / 20 / 25

M-Tec 428



M-TEC

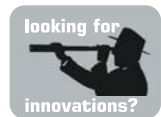
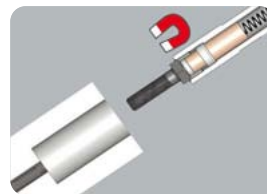

toolcase 6-pcs / Koffer 6-tlg.

Item No



EAN-Code

428 106 36

952

40 07157 61373 8

(6 x) 428: 5,5 x 110 / 6 x 110 / 7,0 x 110 / 8,0 x 110
10,0 x 125 / 13,0 x 125



Inox



To be used on stainless steel screws and objects. Prevents corrosive abrasion and extraneous rust.

Für Edelstahlschrauben und -Werkstücke.
Verhindert korrodierenden Abrieb und Fremdrost.

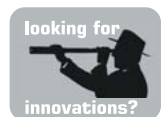

400



ERGONIC Inox set 6 pcs. / ERGONIC Inox Satz 6-tlg.

Item No



EAN-Code

400 861 18

600

40 07157 62755 1

(2 x) 440: 4,0 x 100 / 6,5 x 150

(1 x) 441: PZ2 x 100

(1 x) 442: PH2 x 100

(2 x) 448: Torx® 20 x 100 / Torx® 25 x 100

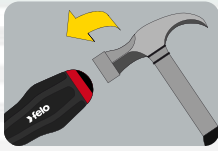

steelcap
Stahl-Schlagkappe



pleasant soft grip material for highest torque
angenehm griffiger Weichmantel für höchste Drehmomente



www.tuv.com
ID 0000038668

GS tested for safety
GS - geprüfte Sicherheit

The strongest of series 500
Die Stärksten aus der Serie 500

Serie 550

steelcap / Stahl-Schlagkappe

full length blade / Durchgehende Klinge

hexagon bolster / Schlüsselhilfe

hexagon blade / Sechskantklinge



hexagon bolster
Schlüsselhilfe

anti-roll handle design
Griffkopf mit Abrollschutz

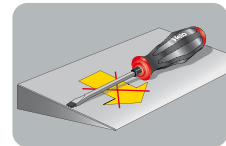

hexagon blades manufactured from chrome-molybdenum-vanadium steel

Sechskantklingen aus spezieller Chrom-Molybdän-Vanadium-Legierung



superior torque which exceeds DIN and ISO requirements by up to 100%

Beste Leistungsdaten, bis zu 100% über DIN-Werten

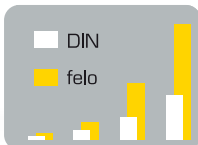

EAN code on every product

EAN-Code auf jedem Werkzeug

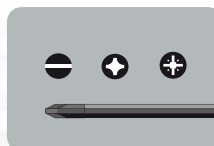

black tip for precision fit

Black-Tip für präzise Passung

full length blade

Durchgehende Klinge

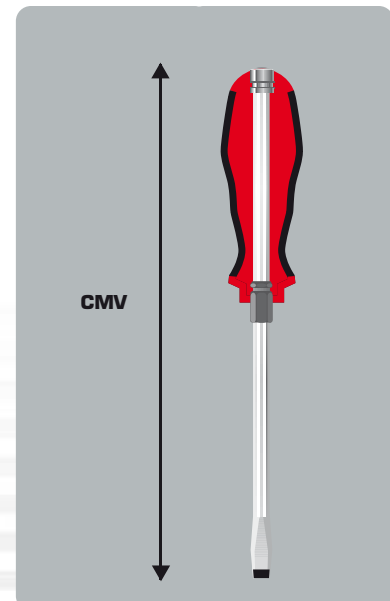

550



								Item No		EAN-Code
4,5 x 0,8	100	90	29	5,0	12		550 045 40	84	40 07157 50699 3	
5,5 x 1,0	100	99	34	5,0	12		550 055 40	101	40 07157 32354 5	
6,5 x 1,2	125	99	34	6,35	12		550 065 40	128	40 07157 32356 9	
8,0 x 1,2	155	105	38	8,0	6		550 080 40	202	40 07157 32358 3	
9,0 x 1,6	165	105	38	8,0	6		550 090 40	204	40 07157 50701 3	
10,0 x 1,6	175	105	38	8,0	6		550 100 40	211	40 07157 32360 6	
12,0 x 2,0	200	105	38	10,0	6		550 120 40	291	40 07157 32362 0	

551



PZ								Item No		EAN-Code
1	90	90	29	5,0	12		551 102 40	82	40 07157 51701 2	
2	100	99	34	6,35	12		551 203 40	122	40 07157 32364 4	
3	155	105	38	8,0	6		551 305 40	202	40 07157 32366 8	

552



PH								Item No		EAN-Code
1	90	90	29	5,0	12		552 102 40	82	40 07157 50703 7	
2	100	99	34	6,35	12		552 203 40	122	40 07157 32368 2	
3	155	105	38	8,0	6		552 305 40	201	40 07157 32370 5	

550

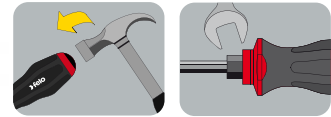

Item No



EAN-Code

Set 6-pce / Satz 6-tlg

550 961 47

1145

40 07157 53709 6

(3 x) 550: 6,5 x 1,2 x 125 / 8,0 x 1,2 x 155 / 10,0 x 1,6 x 175

(3 x) 552: PH 1 x 90 / PH 2 x 100 / PH 3 x 155

550

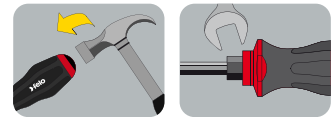

Item No



EAN-Code

Set 5-pce / Satz 5-tlg

550 952 48

633

40 07157 50707 5

(3 x) 550: 4,5 x 100 / 5,5 x 100 / 6,5 x 125

(2 x) 552: PH 1 x 90 / PH 2 x 100

550

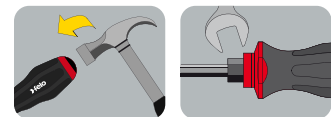

Item No



EAN-Code

Set 5-pce / Satz 5-tlg

550 951 48

870

40 07157 32386 6

(3 x) 550: 5,5 x 100 / 6,5 x 125 / 8,0 x 155

(2 x) 552: PH 2 x 100 / PH 3 x 155

550

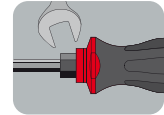
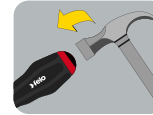

Set 3-pce / Satz 3-tlg

Item No

EAN-Code

(3 x) 550 5,5 x 100 / 6,5 x 125 / 8 x 155

550 932 44

481

40 07157 53669 3



Reliability and a long
lifespan are essential for
good tools.

Zuverlässigkeit und lange
Lebensdauer machen gutes
Werkzeug aus.

A handwritten signature in black ink, which appears to be "Dr. von Kitz".



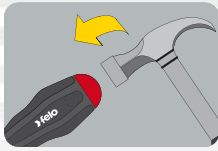

full length, impact proof handle core
durchgehender, schlagfester Hartkern

smooth, seamless handle for maximum comfort

nahtfrei glatte Kappe für minimale Reibung

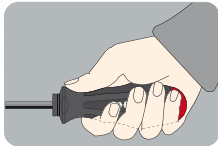

pleasant soft grip material for highest torque
angenehm griffiger Weichmantel für höchste Drehmomente

GS tested for safety

GS - geprüfte Sicherheit



The Original *Das Original* Serie 500

The leaders in *Führend in Design,*
handle-design *Ergonomie*
blade quality *Klingenqualität*
2-component- *2Komponentengriff-*
technology *Technik*

blades manufactured from chrome-molybdenum-vanadium steel

Klingen aus spezieller Chrom-Molybdän-Vanadium-Legierung

ergonomically refined design

ergonomisch ausgereiftes Design

superior torque which exceeds DIN and ISO requirements by up to 100%

Beste Leistungsdaten, bis zu 100% über DIN-Werten

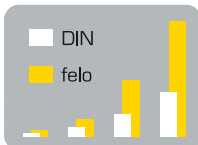

hanging hole for easy storage or inserting lever

Querloch: Zum Aufhängen der Werkzeuge oder zum Einstecken eines Hebels

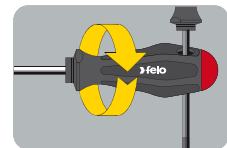
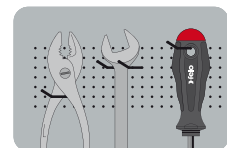
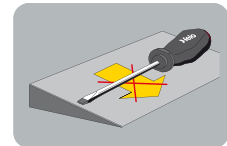

EAN code on every product

EAN-Code auf jedem Werkzeug



black tip for precision fit

Black-Tip für präzise Passung



500



							Item No		EAN-Code
2,5 x 0,4	75	80	25	2,5	12		500 022 10	27	40 07157 22091 2
3,0 x 0,5	80	80	25	3,0	12		500 032 10	29	40 07157 22092 9
3,5 x 0,6	100	80	25	3,5	12		500 353 10	33	40 07157 22093 6
4,0 x 0,8	100	90	29	4,0	12		500 043 10	48	40 07157 22094 3
4,0 x 0,8	200	90	29	4,0	12		500 047 10	58	40 07157 50693 1
4,0 x 0,8	300	90	29	4,0	12		500 049 10	68	40 07157 51379 3
5,5 x 0,8	125	99	34	5,0	12		500 504 10	77	40 07157 52315 0
5,0 x 0,8	150	99	34	5,0	12		500 505 10	76	40 07157 50572 9
5,5 x 1,0	125	99	34	5,0	12		500 554 10	79	40 07157 22095 0
5,5 x 1,0	150	99	34	5,0	12		500 556 10	83	40 07157 51811 8
5,5 x 1,0	200	99	34	5,0	12		500 557 10	92	40 07157 53697 6
5,5 x 1,0	300	99	34	5,0	12		500 559 10	111	40 07157 50695 5
6,5 x 1,2	100	99	34	6,0	12		500 656 10	77	40 07157 51841 5
6,5 x 1,2	150	99	34	6,0	12		500 655 10	89	40 07157 22096 7
6,5 x 1,2	200	99	34	6,0	12		500 657 10	102	40 07157 51843 9
6,5 x 1,2	500	105	39	6,0	6		500 610 10	190	40 07157 53699 0
8,0 x 1,2	175	105	39	7,0	12		500 086 10	127	40 07157 22097 4
8,0 x 1,2	300	105	39	8,0	6		500 088 10	198	40 07157 51809 5
8,0 x 1,6	175	105	39	8,0	6		500 096 10	149	40 07157 22098 1
10,0 x 1,6	200	105	39	8,0	6		500 107 10	156	40 07157 50697 9

501



PZ							Item No		EAN-Code
0	60	80	25	3,0	12		501 001 10	28	40 07157 22100 1
1	80	90	29	4,5	12		501 102 10	49	40 07157 22101 8
2	100	99	34	6,0	12		501 203 10	79	40 07157 22102 5
2	200	99	34	6,0	6		501 207 10	102	40 07157 22105 6
2	300	99	34	6,0	6		501 209 10	125	40 07157 51769 2
3	150	105	39	8,0	6		501 305 10	140	40 07157 31330 0
4	150	105	39	10,0	6		511 405 40	218	40 07157 30856 6

502



PH							Item No		EAN-Code
0	60	80	25	3,0	12		502 001 10	28	40 07157 22106 3
1	80	90	29	4,5	12		502 102 10	48	40 07157 22107 0
1	200	90	29	4,5	12		502 107 10	65	40 07157 22111 7
2	100	99	34	6,0	12		502 203 10	80	40 07157 22108 7
2	150	99	34	6,0	12		502 205 10	90	40 07157 51845 3
2	200	99	34	6,0	6		502 207 10	101	40 07157 22112 4
2	300	99	34	6,0	6		502 209 10	123	40 07157 51381 6
2	500	99	34	6,0	6		502 210 10	187	40 07157 57813 6
3	150	105	39	8,0	6		502 305 10	138	40 07157 31331 7

Stubby



							Item No		EAN-Code
5,5 x 1,0	25	57	35	5,0	12		500 550 10	35	40 07157 22099 8
PZ 1	25	57	35	4,5	12		501 010 10	33	40 07157 22103 2
PZ 2	25	57	35	6,0	12		501 020 10	37	40 07157 22104 9
PH 1	25	57	35	4,5	12		502 010 10	33	40 07157 22109 4
PH 2	25	57	35	6,0	12		502 020 10	38	40 07157 22110 0

507



Torx® TR						Item No		EAN-Code
10	100	80	25	3,5	12	507 103 40	33	40 07157 32234 0
15	100	90	29	4,0	12	507 153 40	47	40 07157 32236 4
20	100	99	34	4,0	12	507 203 40	69	40 07157 32238 8
25	100	99	34	5,0	12	507 253 40	68	40 07157 32240 1
27	100	99	34	5,0	12	507 273 40	70	40 07157 32242 5
30	115	105	39	6,0	6	507 303 40	98	40 07157 32244 9
40	125	105	39	8,0	6	507 404 40	130	40 07157 32246 3

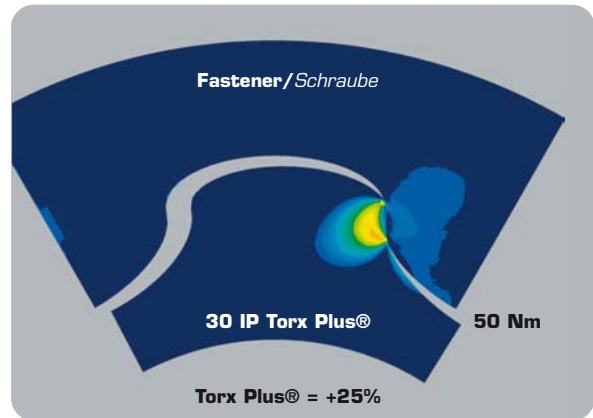
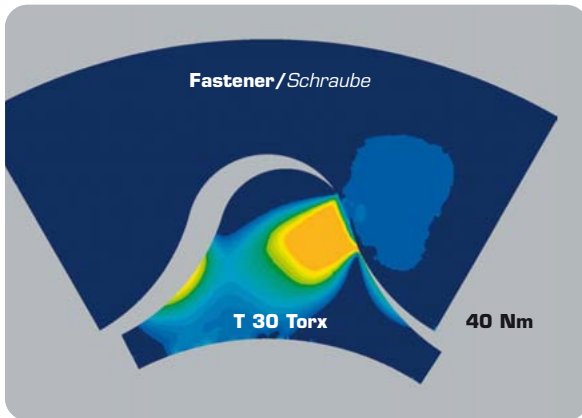

508



Torx®						Item No		EAN-Code
5	60	68	20	3,0	12	508 051 40	15	40 07157 22188 9
6	60	68	20	3,0	12	508 061 40	15	40 07157 22154 4
7	60	80	25	3,0	12	508 071 40	28	40 07157 22156 8
8	60	80	25	3,0	12	508 083 40	28	40 07157 22157 5
9	60	80	25	3,5	12	508 093 40	28	40 07157 22158 2
10	100	80	25	3,5	12	508 103 40	33	40 07157 22159 9
15	100	90	29	4,0	12	508 153 40	48	40 07157 22160 5
20	100	99	34	5,0	12	508 203 40	69	40 07157 22161 2
25	100	99	34	5,0	12	508 253 40	69	40 07157 22162 9
27	100	99	34	5,0	12	508 273 40	70	40 07157 22163 6
30	115	105	39	6,0	6	508 303 40	96	40 07157 22164 3
40	125	105	39	8,0	6	508 404 40	129	40 07157 22165 0
45	125	105	39	8,0	6	508 454 40	129	40 07157 22166 7

509



Torx Plus®						Item No		EAN-Code
IP 6	60	68	20	3,0	12	509 061 40	17	40 07157 51319 9
IP 7	60	80	25	3,0	12	509 071 40	28	40 07157 51321 2
IP 8	60	80	25	3,0	12	509 083 40	29	40 07157 51323 6
IP 9	60	80	25	3,0	12	509 093 40	30	40 07157 51325 0
IP 10	100	80	25	3,5	12	509 103 40	33	40 07157 51327 4
IP 15	100	90	29	4,0	12	509 153 40	48	40 07157 51329 8
IP 20	100	99	34	5,0	12	509 203 40	69	40 07157 51331 1
IP 25	100	99	34	5,0	12	509 253 40	69	40 07157 51333 5
IP 27	100	99	34	5,0	12	509 273 40	70	40 07157 51335 9
IP 30	115	105	39	6,0	6	509 303 40	97	40 07157 51337 3
IP 40	125	105	39	8,0	6	509 404 40	130	40 07157 51339 7

500

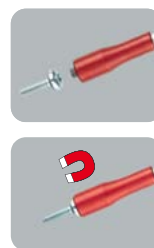

														Item No		EAN-Code
	3,0 x 0,5	80	80	25	3,0	6								500 032 30	30	40 07157 51681 7
	3,0 x 0,5	200	80	25	3,0	6								500 037 30	36	40 07157 51981 8
	3,5 x 0,6	100	80	25	3,5	6								500 353 30	34	40 07157 51683 1
	3,5 x 0,6	250	80	25	3,5	6								500 358 30	46	40 07157 51983 2
	4,0 x 0,8	100	90	29	4,0	6								500 043 30	50	40 07157 51685 5
	4,0 x 0,8	200	90	29	4,0	6								500 047 30	60	40 07157 51757 9

501

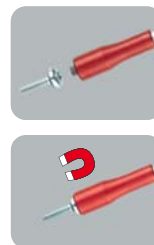

	PZ												Item No		EAN-Code
	1	80	90	29	4,5	6							501 102 30	52	40 07157 51677 0
	2	100	99	34	6,0	6							501 203 30	84	40 07157 51679 4
	2	200	99	34	6,0	6							501 207 30	108	40 07157 51759 3

502

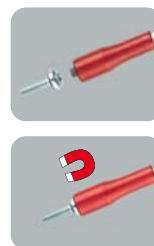

	PH												Item No		EAN-Code
	1	80	90	29	4,5	6							502 102 30	50	40 07157 51673 2
	1	200	90	29	4,5	6							502 107 30	68	40 07157 51985 6
	2	100	99	34	6,0	6							502 203 30	84	40 07157 51675 6
	2	200	99	34	6,0	6							502 207 30	106	40 07157 51761 6

508

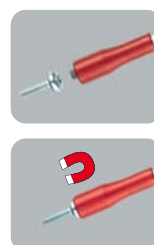

	Torx®											Item No		EAN-Code	
	10	100	80	25	3,5	6							508 103 30	34	40 07157 51665 7
	15	100	90	29	4,0	6							508 153 30	50	40 07157 51667 1
	20	100	99	34	5,0	6							508 203 30	72	40 07157 51669 5
	25	100	99	34	5,0	6							508 253 30	73	40 07157 51671 8

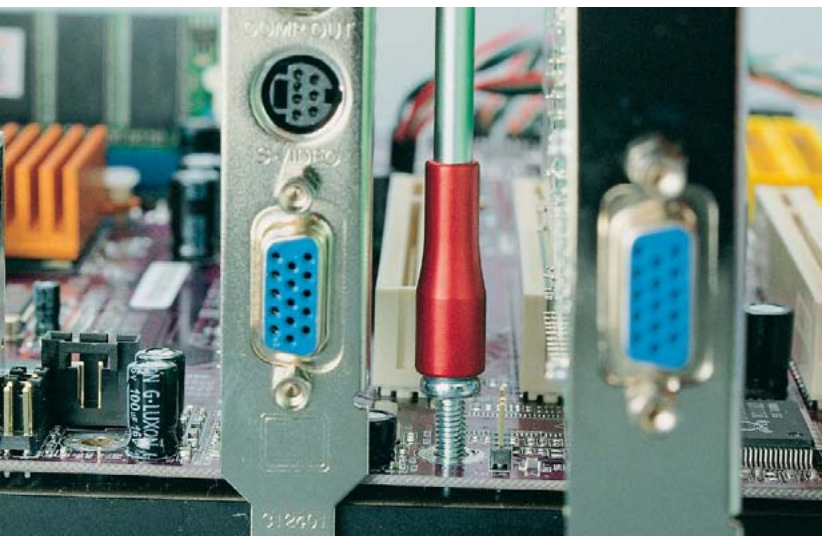

520



4,0 x 0,8	155	90	29	4,0	6
5,5 x 1,0	155	99	34	5,5	6



Item No

520 045 10

520 055 10



66

92



EAN-Code

40 07157 50072 4

40 07157 50074 8

522



PH					
1	155	90	29	4,0	6
2	155	99	34	5,5	6



Item No

522 105 10

522 205 10



66

91



EAN-Code

40 07157 50076 2

40 07157 50078 6

538



Star-				
100	100	99	34	6



Item No

538 100 40



102



EAN-Code

40 07157 51397 7

Automatikhalter 1/4"

527



mm	Diagram			Hex	Box	Item No	Unit	EAN-Code
2	75	80	25	2,0	12	527 202 40	26	40 07157 22167 4
2,5	100	80	25	2,5	12	527 253 40	29	40 07157 22168 1
3	100	80	25	3,0	12	527 303 40	32	40 07157 22169 8
4	100	90	29	4,0	12	527 403 40	50	40 07157 22170 4
5	100	99	34	5,0	12	527 503 40	72	40 07157 22171 1
6	125	99	34	6,0	12	527 604 40	90	40 07157 22178 0
8	150	105	39	8,0	12	527 805 40	149	40 07157 22173 5

528



mm	Diagram			Hex	Box	Item No	Unit	EAN-Code
4	125	90	29		12	528 040 40	63	40 07157 22174 2
5	125	90	29		12	528 050 40	64	40 07157 22175 9
5,5	125	90	29		12	528 055 40	64	40 07157 22176 6
5,5	200	90	29		12	528 058 40	76	40 07157 50769 3
6	125	90	29		12	528 060 40	66	40 07157 22177 3
6	250	90	29		12	528 068 40	85	40 07157 22189 6
7	125	99	34		12	528 070 40	95	40 07157 22179 7
7	250	99	34		6	528 078 40	123	40 07157 22180 3
8	125	99	34		12	528 080 40	97	40 07157 22181 0
9	125	99	34		12	528 090 40	97	40 07157 22182 7
10	125	99	34		12	528 100 40	101	40 07157 22183 4
11	125	105	39		12	528 110 40	151	40 07157 22184 1
12	125	105	39		12	528 120 40	154	40 07157 22185 8
13	125	105	39		12	528 130 40	156	40 07157 22186 5
14	125	105	39		12	528 140 40	156	40 07157 22187 2

538



1/4"	Diagram			Hex	Box	Item No	Unit	EAN-Code
100	99	34		6	538 125 40	102	40 07157 32348 4	

597



Diagram	Hex	Box	Item No	Unit	EAN-Code
90 29		12	597 200 00	55	40 07157 62403 1

Bottle Opener / Flaschenöffner

500



	Item No		EAN-Code
Set 6-pcs / Satz 6-tlg	500 961 17	570	40 07157 50174 5
(4 x) 500:	3,5 x 100 / 4,0 x 100 / 5,5 x 125 / 6,5 x 150		
(2 x) 502:	PH 1 x 80 / PH 2 x 100		

500



	Item No		EAN-Code
Set 6-pcs / Satz 6-tlg	500 963 17	590	40 07157 51311 3
(2 x) 500:	4,0 x 100 / 6,5 x 150		
(2 x) 501:	PZ 1 x 80 / PZ 2 x 100		
(2 x) 502:	PH 1 x 80 / PH 2 x 100		

508



	Item No		EAN-Code
Set 6-pcs / Satz 6-tlg	508 961 47	642	40 07157 50178 3
(6 x) 508:	Torx 10 / 15 / 20 / 25 / 30 / 40		



508



Set 7-pcs / Satz 7-tlg

(7 x) 508: Torx 6 / 8 / 10 / 15 / 20 / 25 / 30

Item No

508 971 47



558

EAN-Code

40 07157 50705 1



500



Set 7-pcs / Satz 7-tlg

(3 x) 500: 3,0 x 80 / 3,5 x 100 / 4,0 x 100

(2 x) 502: PH 1 x 80 / PH 2 x 100

(2 x) 508: Torx 10 x 100 / Torx 15 x 100

Item No

500 971 37



522

EAN-Code

40 07157 51699 2



500



Set 3-pcs / Satz 3-tlg

(1 x) 500: 4,0 x 200

(2 x) 502: PH 1 x 80 / PH 2 x 200

Item No

500 933 34



266

EAN-Code

40 07157 51857 6



508



Set 3-pcs / Satz 3-tlg

[3 x] **508:** Torx 10 / Torx 15 / Torx 20

Item No

508 931 34



204

EAN-Code

40 07157 51855 2

500



Set 3-pcs / Satz 3-tlg

[1 x] **500:** 4,0 x 300



[1 x] **501:** PZ 2 x 300



[1 x] **502:** PH 2 x 300

Item No

500 931 14



363

EAN-Code

40 07157 51775 3

500



Set 3-pcs / Satz 3-tlg

500: 5,5 x 125 / 6,5 x 150



502: PH 2 x 100

Item No

500 934 14



292

EAN-Code

40 07157 53707 2

500



Set 5-pcs / Satz 5-tlg

[3 x] **500:** 4,0 x 100 / 5,5 x 125 / 6,5 x 150



[2 x] **502:** PH 1 x 80 / PH 2 x 100

Item No

500 951 18



452

EAN-Code

40 07157 22062 2



500



Item No  EAN-Code

Set 7-pcs / Satz 7-tlg	500 971 18	552	40 07157 22134 6
(4 x) 500 : 3,5 x 100 / 4,0 x 100 / 5,5 x 125 / 6,5 x 150			
(1 x) 501 : PZ 2 x 100			
(2 x) 502 : PH 1 x 80 / PH 2 x 100			



507



Item No  EAN-Code

Set 6-pcs Torx® TR/ Satz 6-tlg	507 961 48	548	40 07157 50823 2
(6 x) 507 : Torx® TR 10 / Torx® TR 15 / Torx® TR 20 / Torx® TR 25 / Torx® TR 30 / Torx® TR 40			





500



Item No  EAN-Code

Promo Pack 500 / 513 VDE (440 mm / 325 mm / 305 mm)	500 924 00	10654	40 07157 51439 4
(16 x) 500 951 18			
(3 x) 500 : 4,0 x 100 / 5,5 x 125 / 6,5 x 150			
(2 x) 502 : PH 1 x 80 / PH 2 x 100			
(8 x) 513 951 98			
(4 x) 513 : 3,0 x 100 / 3,5 x 100 / 4,0 x 100 / 5,5 x 125			
(1 x) 515 : PZ 2 x 100			

   **AC 1000V IEC 60900 : 2012**

500



Item No		EAN-Code
500 112 16	1216	40 07157 22138 4

toolcase 12-pcs / Koffer 12-tlg.

(5 x) **500:** 5,5 x 25 / 3,5 x 100 / 4,0 x 100 / 5,5 x 125 / 6,5 x 150

(1 x) **550:** 8,0 x 155 

(3 x) **501:** PZ 0 x 60 / PZ 1 x 80 / PZ 2 x 100

(3 x) **502:** PH 0 x 60 / PH 1 x 80 / PH 2 x 100



500



Item No		EAN-Code
500 111 16	964	40 07157 32558 7

toolcase 11-pcs / Koffer 11-tlg.

(4 x) **500:** 4,0 x 100 / 5,5 x 25 / 5,5 x 125 / 6,5 x 150

(1 x) **501:** PZ 2 x 100

(3 x) **502:** PH 1 x 80 / PH 2 x 25 / PH 2 x 100

(2 x) **613:** 2,5 x 75 / 3,5 x 100 

(1 x) **361:** **Mains testing screwdriver / Spannungsprüfer**

VDE 0680/6, 220-250 Volt



handles manufactured from shock-proof polypropylene

Griffe aus schlagfestem Polypropylen

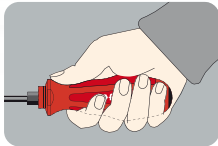

ergonomically refined design

ergonomisch ausgereiftes Design

steelcap

Stahl-Schlagkappe

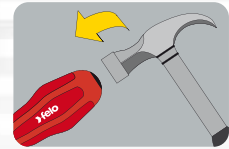

The strongest of series 200
Die Stärksten aus der Serie 200

Serie 206

steelcap / Stahl-Schlagkappe

full length blade / durchgehende Klinge

hexagon bolster / Schlüsselhilfe

hexagon blade / Sechskantklinge

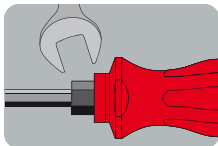

hexagon bolster

Schlüsselhilfe

anti-roll handle design

Griffkopf mit Abrollschutz

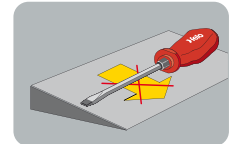

hexagon blades manufactured from chrome-molybdenum-vanadium steel

Sechskantklingen aus spezieller Chrom-Molybdän-Vanadium-Legierung



full length blade

Durchgehende Klinge



GS tested for safety

GS - geprüfte Sicherheit



EAN code on every product

EAN-Code auf jedem Werkzeug

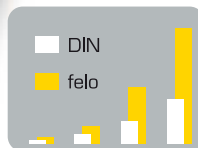

superior torque which exceeds DIN and ISO requirements by up to 100%

Beste Leistungsdaten, bis zu 100% über DIN-Werten

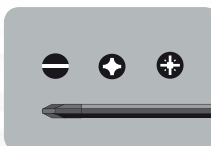

black tip for precision fit

Black-Tip für präzise Passung

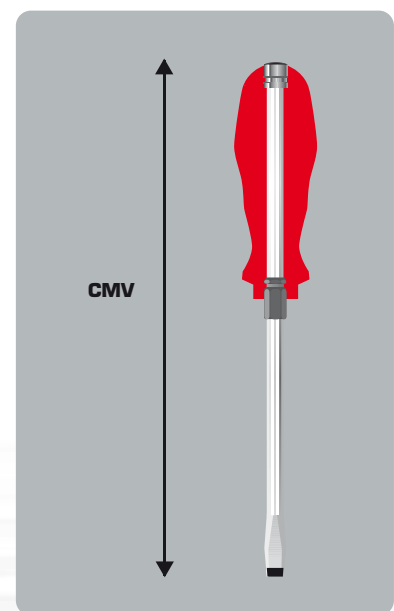

206

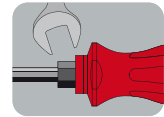
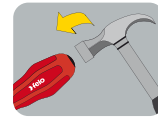

	Item No		EAN-Code
5,5 x 1,0	100 98 34 5,0 12	206 055 90	94 40 07157 31690 5
6,5 x 1,2	125 98 34 6,35 12	206 065 90	120 40 07157 24036 1
8,0 x 1,2	150 105 38 8,0 6	206 080 90	195 40 07157 30876 4
10,0 x 1,6	175 105 38 8,0 6	206 100 90	204 40 07157 13166 9
12,0 x 2,0	200 105 38 10,0 6	206 120 90	286 40 07157 31692 9

216

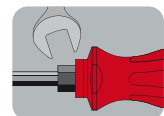
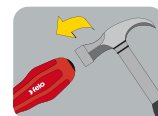

PZ	Item No		EAN-Code
2	100 98 34 6,35 12	216 203 90	115 40 07157 31694 3
3	150 105 38 8,0 6	216 305 90	195 40 07157 31696 7

226

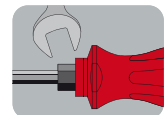
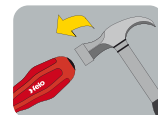

PH	Item No		EAN-Code
2	100 98 34 6,35 12	226 203 90	115 40 07157 31698 1
3	150 105 38 8,0 6	226 305 90	194 40 07157 31700 1

206

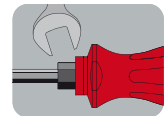
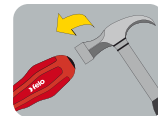

Item No		EAN-Code
206 951 98	Set 5-pcs / Satz 5-tlg. (3 x) 206: 5,5 x 100 / 6,5 x 125 / 8,0 x 150 (2 x) 226: PH 2 x 100 / PH 3 x 150	838 40 07157 31720 9

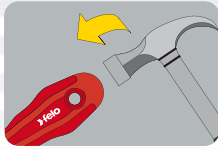

handles manufactured from shock-proof polypropylene

Griffe aus schlagfestem Polypropylen

GS tested for safety

GS - geprüfte Sicherheit

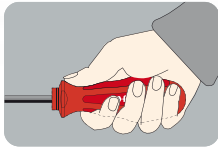

ergonomically refined design

ergonomisch ausgereiftes Design

High quality and comprehensive range Serie 200

*Überragend in Qualität,
Preis und Vielfalt*

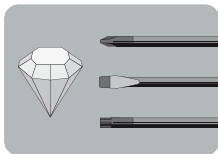

blades manufactured from chrome-molybdenum-vanadium steel

Klingen aus spezieller Chrom-Molybdän-Vanadium-Legierung

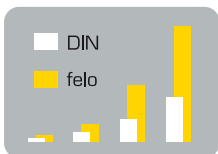

superior torque which exceeds DIN and ISO requirements by up to 100%

Beste Leistungsdaten, bis zu 100% über DIN-Werten

anti-roll handle design

Griffkopf mit Abrollschutz

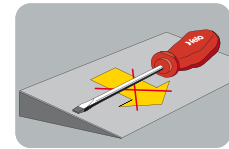

hanging hole for easy storage or inserting lever

*Querloch:
Zum Aufhängen der Werkzeuge oder zum Einstecken eines Hebels*

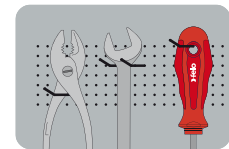

EAN code on every product

EAN-Code auf jedem Werkzeug

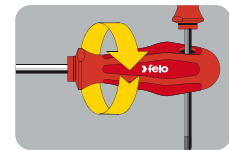

black tip for precision fit

Black-Tip für präzise Passung



200



								Item No		EAN-Code
2,5 x 0,4		75	80	25	2,5	12		200 022 90	24	40 07157 13001 3
3,0 x 0,5		80	80	25	3,0	12		200 032 90	26	40 07157 13003 7
3,5 x 0,6		100	80	25	3,5	12		200 353 90	30	40 07157 13035 8
4,0 x 0,8		100	90	29	4,0	12		200 043 90	43	40 07157 13010 5
5,0 x 0,8		125	90	29	5,0	12		200 054 90	55	40 07157 13016 7
5,5 x 1,0		125	98	34	5,0	12		200 554 90	68	40 07157 13041 9
6,5 x 1,2		125	98	34	6,0	12		200 654 90	79	40 07157 16050 8
6,5 x 1,2		150	98	34	6,0	12		200 655 90	85	40 07157 13051 8
8,0 x 1,2		175	105	38	7,0	12		200 086 90	122	40 07157 13028 0
10,0 x 1,6		200	105	38	8,0	6		200 107 90	151	40 07157 13032 7

201



PZ								Item No		EAN-Code
0		60	80	25	3,0	12		201 001 90	25	40 07157 13076 1
1		80	90	29	4,5	12		201 102 90	44	40 07157 13081 5
2		100	98	34	6,0	12		201 203 90	75	40 07157 13084 6
3		150	105	38	8,0	6		201 305 90	134	40 07157 13089 1

202



PH								Item No		EAN-Code
0		60	80	25	3,0	12		202 001 90	24	40 07157 13099 0
1		80	90	29	4,5	12		202 102 90	44	40 07157 13106 5
2		100	98	34	6,0	12		202 203 90	75	40 07157 13111 9
3		150	105	38	8,0	6		202 305 90	131	40 07157 13117 1

Stubby



								Item No		EAN-Code
5,5 x 1,0		25	58	33	5,0	12		200 550 90	30	40 07157 13037 2
6,5 x 1,2		25	58	33	6,0	12		200 650 90	34	40 07157 13045 7
PZ 2		25	58	33	6,0	12		201 020 90	34	40 07157 13079 2
PH 2		25	58	33	6,0	12		202 020 90	34	40 07157 13103 4

208



Torx®												Item No		EAN-Code
6	60	80	25	3,0	12							208 061 90	23	40 07157 31332 4
7	60	80	25	3,0	12							208 071 90	25	40 07157 31333 1
8	60	80	25	3,0	12							208 083 90	25	40 07157 31334 8
9	60	80	25	3,5	12							208 093 90	24	40 07157 31335 5
10	100	90	29	3,5	12							208 103 90	39	40 07157 31336 2
15	100	90	29	4,0	12							208 153 90	43	40 07157 31337 9
20	100	98	34	5,0	12							208 203 90	64	40 07157 31338 6
25	100	98	34	5,0	12							208 253 90	65	40 07157 31339 3
27	100	98	34	5,0	12							208 273 90	64	40 07157 31340 9
30	115	105	38	6,0	6							208 303 90	91	40 07157 31341 6
40	125	105	38	8,0	6							208 404 90	123	40 07157 31342 3

200



	Item No		EAN-Code
Set 5-pcs / Satz 5-tlg	200 951 98	374	40 07157 16052 2
(3 x) 200: 3,5 x 100 / 4,0 x 100 / 5,5 x 125			
(2 x) 202: PH 1 x 80 / PH 2 x 100			

200



	Item No		EAN-Code
Set 7-pcs / Satz 7-tlg	200 972 98	564	40 07157 16054 6
(5 x) 200: 3,5 x 100 / 4,0 x 100 / 5,5 x 125			
6,5 x 150 / 8,0 x 175			
(2 x) 202: PH 1 x 80 / PH 2 x 100			

200



Item No	EAN-Code
200 973 98	40 07157 16055 3

Set 7-pcs / Satz 7-tlg

(4 x) **200:** 3,0 x 80 / 4,0 x 100 / 5,5 x 125 / 8,0 x 175

(1 x) **201:** PZ 2 x 100

(2 x) **202:** PH 1 x 80 / PH 2 x 100

208



Item No	EAN-Code
208 971 98	40 07157 50468 5

Set 7-pcs / Satz 7-tlg

(7 x) **208:** Torx® 8 / Torx® 10 / Torx® 15 / Torx® 20
Torx® 25 / Torx® 30 / Torx® 40

200



Item No	EAN-Code
200 971 97	40 07157 50108 0

Set 7-pcs / Satz 7-tlg

(3 x) **200:** 4,0 x 0,8 / 5,5 x 1,0 / 6,5 x 1,2

(2 x) **202:** PH 1 x 80 / PH 2 x 100

(1 x) **613:** 3,5 x 0,6

(1 x) **361:** **Mains testing screwdriver / Spannungsprüfer**
VDE 0680/6, 220-250 Volt



200

Item No  **EAN-Code**
200 972 97 552 40 07157 50156 1

Set 7-pcs / Satz 7-tlg

(3 x) **200:** 4,0 x 0,8 / 5,5 x 1,0 / 6,5 x 1,2

(2 x) **201:** PZ 1 x 80 / PZ 2 x 100

(1 x) **613:** 3,5 x 0,6    **AC 1000V IEC 60900 : 2012**

(1 x) **361:** **Mains testing screwdriver / Spannungsprüfer**

VDE 0680/6, 220-250 Volt



200

Item No  **EAN-Code**
200 112 96 1158 40 07157 22152 0

toolcase 12-pcs / Koffer 12-tlg.

(4 x) **200:** 6,5 x 25 / 4,0 x 100 / 5,5 x 125 / 6,5 x 150

(2 x) **201:** PZ 1 x 80 / PZ 2 x 100

(3 x) **202:** PH 0 x 60 / PH 1 x 80 / PH 2 x 100

(1 x) **206:** 8,0 x 150 

(1 x) **613:** 3,5 x 100    **AC 1000V IEC 60900 : 2012**









(1 x) **361:** **Mains testing screwdriver / Spannungsprüfer**

VDE 0680/6, 220-250 Volt



200



	Item No		EAN-Code
toolcase 12-pcs / Koffer 12-tlg.	200 114 96	1163	40 07157 32506 8
(4 x) 200: 4,0 x 100 / 5,5 x 25 / 5,5 x 125 / 6,5 x 150			
(1 x) 201: PZ 2 x 100			
(1 x) 202: PH 2 x 100			
(1 x) 206: 8,0 x 150 			
(3 x) 613: 2,5 x 75 / 3,5 x 100 / 4,0 x 100    AC 1000V IEC 60900 : 2012			
(1 x) 614: PH 1 x 80    AC 1000V IEC 60900 : 2012			
(1 x) 361: Mains testing screwdriver / Spannungsprüfer VDE 0680/6, 220-250 Volt			



When every detail counts you don't make compromises.

Wenn es auf jedes Detail ankommt darf man keine Kompromisse machen.

J. Weijel





Leather cap to protect against splintering

Lederkappe als Splitterschutz

full length blade

Durchgehende Klinge

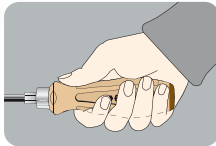
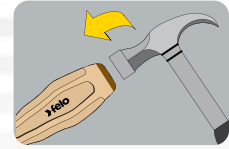

ergonomic handle

ergonomische, ballige Griffkontur

Handle made of hard beechwood

Griff aus besonderem Buche-Hartholz

Commitment to fine, traditional hand tools Serie 330

Handwerklicher Tradition verpflichtet

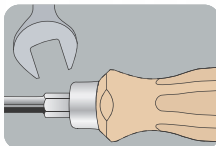

Forged hexagon bolster

Angeschmiedeter Sechskant als Schlüsselhilfe

anti-roll handle design

Griffkopf mit Abrollschutz

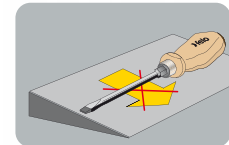

blades manufactured from chrome-molybdenum-vanadium steel

Klingen aus spezieller Chrom-Molybdän-Vanadium-Legierung



full length blade

durchgehende Klinge, schlagfest

superior torque which exceeds DIN and ISO requirements by up to 100%

Beste Leistungsdaten, bis zu 100% über DIN-Werten

EAN code on every product

EAN-Code auf jedem Werkzeug

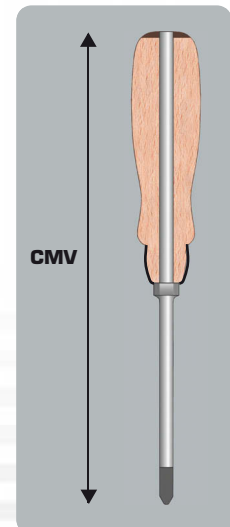

Chrome-plated blade with black tip

Verchromt mit Black-Tip

335

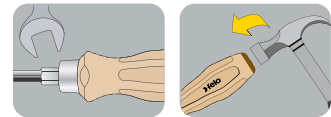

									Item No		EAN-Code
3,5 x 0,6	75	95	24	4,5	12			335 035 90	47	40 07157 18031 5	
4,5 x 0,8	90	95	24	4,5	12			335 045 90	55	40 07157 18032 2	
5,5 x 1,0	100	100	24	5,5	12			335 055 90	72	40 07157 18036 0	
7,0 x 1,2	125	110	30	6,0	12			335 065 90	113	40 07157 18040 7	
9,0 x 1,2	150	120	32	8,0	12			335 080 90	160	40 07157 18043 8	
10,0 x 1,6	175	125	34	9,0	6			335 100 90	184	40 07157 18047 6	
12,0 x 2,0	200	125	34	9,0	6			335 120 90	232	40 07157 18050 6	

336

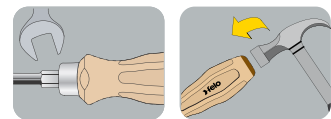

PZ								Item No		EAN-Code
1	80	95	24	4,5	12			336 102 90	47	40 07157 18060 5
2	100	110	30	6,0	12			336 203 90	88	40 07157 18061 2
3	150	120	32	8,0	6			336 305 90	163	40 07157 18062 9

337

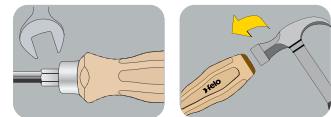

PH								Item No		EAN-Code
1	80	95	24	4,5	12			337 102 90	45	40 07157 18063 6
2	100	110	30	6,0	12			337 203 90	88	40 07157 18067 4
3	150	120	32	8,0	6			337 305 90	164	40 07157 18071 1

335

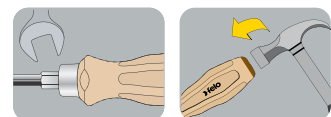

		Item No		EAN-Code
Set 5-pcs / Satz 5-tlg		335 951 98	592	40 07157 22155 1
(3 x) 335:	5,5 x 100 / 7,0 x 125 / 9,0 x 150			
(2 x) 337:	PH 1 x 80 / PH 2 x 100			

335

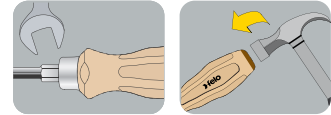

Set 5-pcs / Satz 5-tlg

Item No



EAN-Code

335 952 98

592

40 07157 30762 0

[3 x] **335:** 5,5 x 100 / 7,0 x 125 / 9,0 x 150

[2 x] **336:** PZ 1 x 80 / PZ 2 x 100

335

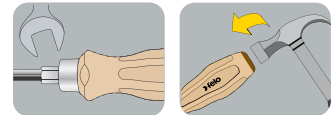

Set 7-pcs / Satz 7-tlg

Item No



EAN-Code

335 971 98

714

40 07157 18108 4

[4 x] **335:** 4,5 x 90 / 5,5 x 100 / 7,0 x 125 / 9,0 x 150

[1 x] **336:** PZ 2 x 100

[2 x] **337:** PH 1 x 80 / PH 2 x 100

057



XS 18 Classic

18-pcs / Satz 18-tlg

Item No



EAN-Code

057 718 66

513

40 07157 62367 6

[1 x] **Mini Ratchet 1/4" / Miniratsche 1/4"**

[7 x] **Sockets / Steckschlüsseleinsätze** 5mm / 5,5mm / 6mm / 7mm / 8mm / 10mm / 13mm

[7 x] **Bits (C6,3 x 25mm)**

4,5 x 0,6 / 5,5 x 0,8 / 6,5 x 1,2 / PZ2 / PH1 / PH2 / PH3

[1 x] **Extension / Verlängerung (50mm) 1/4" - 1/4"**

[1 x] **Adapter / Adapter C 6,3 - 1/4" (25mm) Bitholder / Bithalter E6,3 x 58mm**

Wooden Box / Holzbox 160 mm x 82 mm x 34 mm

490



Awl / Rundahle

60 60 32 4 12

Item No



EAN-Code

490 041 10

36

40 07157 31078 1

493



Awl / Rundahle

100 80 34 6 12

Item No



EAN-Code

493 063 10

72

40 07157 23006 5

498



Reamer / Aufreiber

100 80 34 6 12

Item No



EAN-Code

498 063 10

73

40 07157 23013 3

494



Tacklifter / Reißzweckenheber

100 80 34 12

Item No



EAN-Code

494 003 30

75

40 07157 24022 4

326



Reversible-Blade Screwdriver

12

Item No



EAN-Code

326 965 10

55

40 07157 31068 2

Umsteckschraubendreher

5,5 - PH 2 x 60 mm

dto. in PP bag / in Beutel

12

326 965 11

66

40 07157 18104 6

12 interchangeable IEC screwdriver blades with 2-component handle in sturdy smart box

12 IEC Wechselklingen mit 2-Komponenten-Griff in robuster smart Box

every screwdriver individually tested to 10.000 Volts, fully conforming to DIN EN 60900

Sicherheitswerkzeug nach DIN ISO 60900 – alle Schraubendreher stückgeprüft mit 10.000 Volt

**AC 1000V
IEC 60900 : 2012**



secure fit of blades, quick-release button on handle against unwanted extraction

sicherer Halt der Klingen im Griff, automatische Verriegelung gegen ungewolltes Herausziehen



The first compact smart tool for electricians.
Esmart (pat.)

Das erste kompakte smart-Werkzeug für Elektriker.



precision cap and soft-grip zone on blades for low torque application

aufsteckbare Drehkappe und Weichmantelzone für Einsatz als Feinwerkzeuge





AC 1000V
IEC 60900 : 2012



063



		Item No		EAN-Code
Felo E-SMART	Box 14-pce / Box 14-tlg.	063 913 06	984	40 07157 51719 7
(12 x)	Blade / Klinge			
	2,5 x 0,4 / 3,0 x 0,5 / 3,5 x 0,6 / 4,0 x 0,8 / 5,5 x 1,0 / 6,5 x 1,2			
	PZ 2			
	PH 1 / 2			
	Torx® 10 / 15 / 20			
	Handle / Griff 95 x 32 mm			
	Precision Cap / Drehkappe			
	StrongBox 230mm x 130mm x 56mm			



AC 1000V
IEC 60900 : 2012



063



		Item No		EAN-Code
Felo E-SMART Box in Blister	Box 14-pce / Box 14-tlg.	063 913 01	1044	40 07157 53077 6
(12 x)	Blade / Klinge			
	2,5 x 0,4 / 3,0 x 0,5 / 3,5 x 0,6 / 4,0 x 0,8 / 5,5 x 1,0 / 6,5 x 1,2			
	PZ 2			
	PH 1 / 2			
	Torx® 10 / 15 / 20			
	Handle / Griff 95 x 32 mm			
	Precision Cap / Drehkappe			
	StrongBox 230mm x 130mm x 56mm			



AC 1000V
IEC 60900 : 2012



063



Item No







EAN-Code

Felo E-SMART Industry Box 14-pce / Box 14-tlg.	063 913 16	1071	40 07157 53263 3
(10 x) Blade / Klinge			
2,5 x 0,4 / 3,0 x 0,5 / 3,5 x 0,6 / 4,0 x 0,8 / 5,5 x 1,0 / 6,5 x 1,2			
PZ 2			
PH 1 / 2			
Z 2			
Bit: Spanner 10 x 25			
Universal Cabinet key / Schaltschrankschlüssel			
Handle / Griff 95 x 32 mm			
Precision Cap / Drehkappe			
StrongBox 230mm x 130mm x 56mm			

063



-  (1 x) Spanner 10
-  (3 x) 5 mm, 6, 7
-  (1 x) 9 mm
-  (1 x) 3 - 5 mm
-  (1 x) 1/4"

Item No



EAN-Code

Universal Cabinet Key (in Blister) / Schaltschrankschlüssel (in Blister)	063 999 01	157	40 07157 62417 8
---	-------------------	-----	------------------



50

063



AC 1000V
IEC 60900 : 2012



EAN-Code

Item No	Item Description	Quantity	EAN-Code
063 919 04	Zip-Bag 19-pcs/ Reissverschlussstasche 19-tlg. (14 x)	1550	40 07157 60353 1
	Blade / Klinge		
	2,5 x 0,4 / 3,0 x 0,5 / 3,5 x 0,6 / 4,0 x 0,8 / 5,5 x 1,0 / 6,5 x 1,2		
	PZ 2		
	PH 1 / 2		
	Torx® 10 / 15 / 20		
	H 2		
	Z 2		
	Handle / Griff 95 x 32 mm		
	Precision Cap / Drehkappe		
	Combination Pliers / Kombizange 180 mm		
	Diagonal Nippers / Seitenschneider 160 mm		
	Mains testing Screwdriver / Spannungsprüfer 3,0 mm x 70 mm (VDE 0680/6, 150-250 Volt)		
	Nylon bag / Nylon Tasche 310 mm, 190 mm, 70 mm		



VDE slim blades for Series Nm

Individually tested according EN 60900:2012

VDE slim Klängen für die Serie Nm

stückgeprüft nach EN 60900:2012



Insulation up to 50% slimmer!

Isolierung bis zu 50% schlanker!



Neu!

108



AC 1000V
IEC 60900 : 2012



Nm VDE slim		Nm max			Item No	Quantity	EAN-Code
3,5 x 0,6	170		1/4"	1	100 353 94	23	40 07157 63865 6
4,0 x 0,8	170		1/4"	1	100 043 94	24	40 07157 63863 2
5,5 x 1,0	170		1/4"	1	100 554 94	26	40 07157 63867 0
PH1	170		1/4"	1	101 102 94	26	40 07157 63869 4
PH2	170		1/4"	1	101 203 94	31	40 07157 63871 7
PZ1	170		1/4"	1	102 102 94	26	40 07157 63873 1
PZ2	170		1/4"	1	102 203 94	31	40 07157 63875 5
H2 +/-	170		1/4"	1	106 203 94	31	40 07157 63877 9
Z1 +/-	170		1/4"	1	107 102 94	31	40 07157 63879 3
Z2 +/-	170		1/4"	1	107 203 94	31	40 07157 63881 6





Ergonic, the first handle that adapts to the user's hand!

Ergonic, der erste Griff, der sich der Hand anpasst!



smooth, seamless handle for maximum comfort

nahtfrei glatte Kappe für minimale Reibung

hand and handle interlock, causing less strain

Hand und Griff verzahnen sich – der Kraftaufwand sinkt

VDE Serie 400 **ERGONIC**® (pat.)

stronger / stärker
adaptable / anpassungsfähig
truly ergonomic / wirklich ergonomisch

**AC 1000V
IEC 60900 : 2012**



blades manufactured from chrome-molybdenum-vanadium steel

Klingen aus spezieller Chrom-Molybdän-Vanadium-Legierung

hanging hole for easy storage or inserting lever

Querloch: Zum Aufhängen der Werkzeuge oder zum Einstecken eines Hebels

anti-roll handle design

Abrollschutz

screw symbols on handle cap

Schraubensymbole auf Griffkappe



GS tested for safety

GS – geprüfte Sicherheit

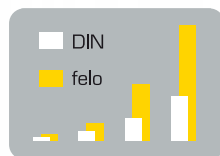

superior torque which exceeds DIN and ISO requirements by up to 100%

Beste Leistungsdaten, bis zu 100% über DIN-Werten

EAN code on every product

EAN-Code auf jedem Werkzeug



full length, impact proof handle core

durchgehender, schlagfester Hartkern



black tip for precision fit

Black-Tip zur Erhaltung der Präzision und Passgenauigkeit

413



AC 1000V
IEC 60900 : 2012



						Item No		EAN-Code
2,5 x 0,4	75	86	25	2,5	12	413 025 90	28	40 07157 53133 9
3,0 x 0,5	100	86	25	3,0	12	413 030 90	32	40 07157 53135 3
3,5 x 0,6	100	86	25	3,5	12	413 035 90	34	40 07157 53139 1
3,5 x 0,8	100	86	25	3,5	12	413 038 90	34	40 07157 61731 6
4,0 x 0,8	100	94	30	3,5	12	413 040 90	46	40 07157 53141 4
4,5 x 1,0	125	101	33	4,5	12	413 045 90	69	40 07157 53143 8
5,5 x 1,0	125	101	33	4,5	12	413 055 90	68	40 07157 53145 2
6,5 x 1,2	150	106	36	5,5	6	413 065 90	100	40 07157 53147 6
8,0 x 1,2	175	112	39	7,0	6	413 080 90	140	40 07157 53149 0

414



AC 1000V
IEC 60900 : 2012



PH						Item No		EAN-Code
0	60	86	25	3,0	12	414 001 90	29	40 07157 53151 3
1	80	94	30	5,0	12	414 102 90	51	40 07157 53153 7
2	100	106	36	6,0	12	414 203 90	94	40 07157 53155 1
3	150	112	39	8,0	6	414 304 90	150	40 07157 53157 5

415



AC 1000V
IEC 60900 : 2012



PZ						Item No		EAN-Code
1	80	94	30	5,0	12	415 102 90	51	40 07157 53159 9
2	100	106	36	6,0	12	415 203 90	94	40 07157 53161 2
3	150	112	39	8,0	6	415 304 90	151	40 07157 53163 6

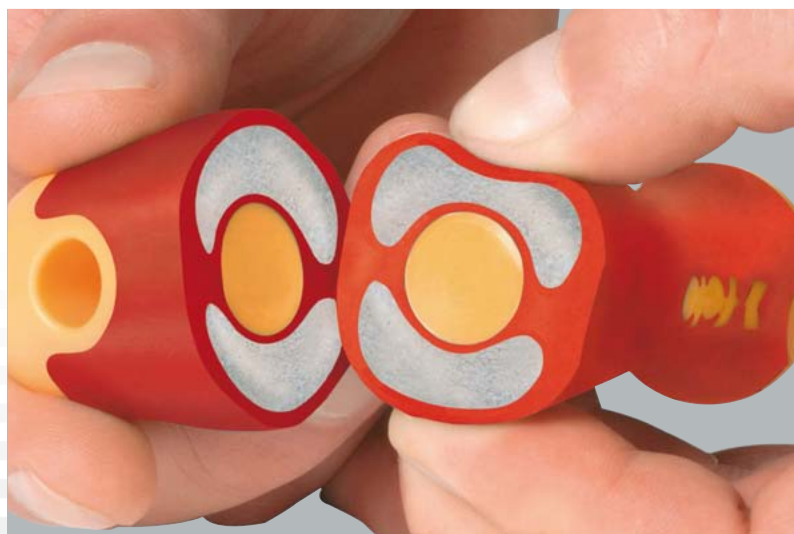

416



AC 1000V
IEC 60900 : 2012



Plus/Minus						Item No		EAN-Code
H1	80	94	30	5,0	12	416 102 90	51	40 07157 60311 1
H2	100	106	36	6,0	12	416 203 90	94	40 07157 60313 5

417



AC 1000V
IEC 60900 : 2012



Plus/Minus						Item No		EAN-Code
Z1	80	94	30	5,0	12	417 102 90	51	40 07157 60315 9
Z2	100	106	36	6,0	12	417 203 90	94	40 07157 60317 3

Neu!

417



AC 1000V
IEC 60900 : 2012

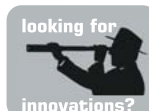

Set 2-pcs Plus/Minus VDE	Item No		EAN-Code
(2 x) 417: Z1 / Z2	417 921 91	290	40 07157 963697 3

418



AC 1000V
IEC 60900 : 2012

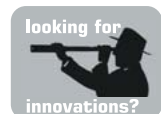

Torx®						Item No		EAN-Code
10	100	86	25	3,5	12	418 103 90	37	40 07157 60369 2
15	100	94	30	3,5	12	418 153 90	54	40 07157 60371 5
20	125	101	33	4,5	12	418 203 90	76	40 07157 60373 9
25	125	106	36	4,5	12	418 253 90	84	40 07157 60375 3
30	150	112	39	6,0	6	418 303 90	118	40 07157 60377 7

419



AC 1000V
IEC 60900 : 2012

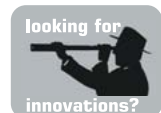

SQ						Item No		EAN-Code
1 (1,75 mm)	100	94	30	3,5	12	419 100 90	35	40 07157 57343 8
2 (2,30 mm)	100	106	36	6,0	12	419 200 90	94	40 07157 57345 2



AC 1000V
IEC 60900 : 2012



Item No



EAN-Code

413

Set 3-pcs VDE / Satz 3-tlg.

413 931 94

254

40 07157 53175 9

[2 x] 413: 4,0 x 100 / 5,5 x 125

[1 x] 414: PH 2 x 100



AC 1000V
IEC 60900 : 2012



Item No



EAN-Code

413

Set 6-pcs VDE / Satz 6-tlg.

413 961 98

506

40 07157 53169 8

[4 x] 413: 3,0 x 100 / 4,0 x 100 / 5,5 x 125 / 6,5 x 150

[2 x] 414: PH 1 x 80 / PH 2 x 100



AC 1000V
IEC 60900 : 2012



Item No



EAN-Code

413

Set 6-pcs VDE / Satz 6-tlg.

413 963 98

413

40 07157 61081 2

[3 x] 413: 2,5 x 75 / 4,0 x 100 / 5,5 x 125

[2 x] 414: PH 1 x 80 / PH 2 x 100

[1 x] 361: Mains testing screwdriver / Spannungsprüfer VDE 0680/6, 220-250 Volt





413

AC 1000V
IEC 60900 : 2012



EAN-Code

toolcase 6-pcs VDE / Koffer 6-tlg.

Item No

413 106 36

629

40 07157 64413 8

(4 x) 413: 3,0 x 100 / 4,0 x 100 / 5,5 x 125

(2 x) 414: PH 1 x 80 / PH 2 x 100

(2 x) 415: PZ 2 x 100



413

AC 1000V
IEC 60900 : 2012



EAN-Code

Ergonic XL-Rack 10-pcs VDE / XL Rack 10 tlg. VDE

Item No

414 910 93

1224

40 07157 63631 7

(4 x) 413: 2,5 x 75 / 3,5 x 100 / 4,0 x 100 / 5,5 x 125

(3 x) 414: PH 0 x 60 / PH 1 x 80 / PH 2 x 100

(1 x) 415: PZ 2 x 100

(2 x) 418: Torx® 10 x 100 / Torx® 20 x 125

(1 x) Steel Rack / Werkzeuhalter (Stahl)



M-TEC

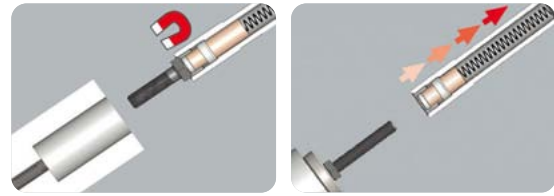

AC 1000V
IEC 60900 : 2012



419

MTEc					Item No		EAN-Code
5,5	110	94	30	12	419 055 30	103	40 07157 60297 8
6	110	94	30	12	419 060 30	104	40 07157 60351 7
7	110	94	30	12	419 070 30	114	40 07157 60299 2
8	110	101	33	12	419 080 30	133	40 07157 60301 2
10	125	101	33	12	419 100 30	140	40 07157 60303 6
13	125	106	36	12	419 130 30	237	40 07157 60305 0



M-TEC

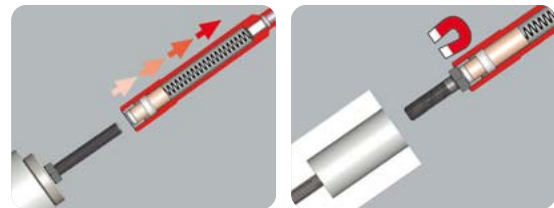

AC 1000V
IEC 60900 : 2012

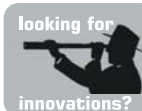

419

	Item No		EAN-Code
toolcase 6 pcs M-Tec VDE / Koffer 6-tlg. M-Tec VDE	419 106 36	980	40 07157 61371 4
(6 x) 419: 5,5 x 110 / 6,0 x 110 / 7,0 x 110 / 8,0 x 110 10,0 x 125 / 13,0 x 125			

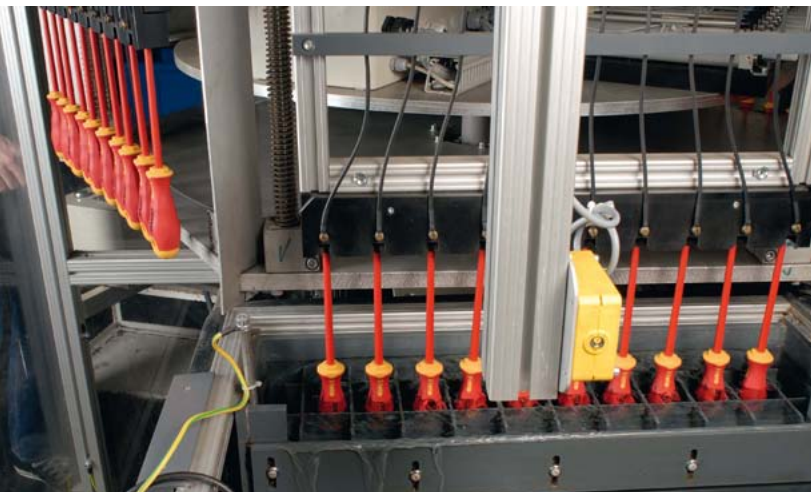

100% testing (10.000 V)

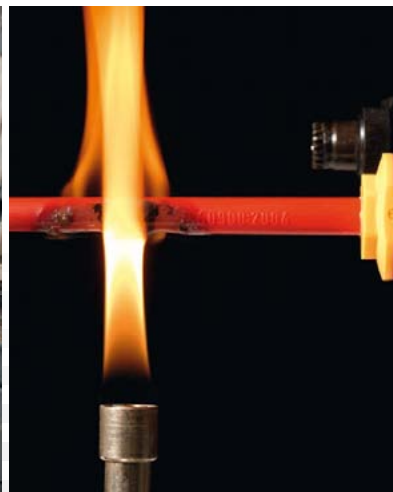

+ 5 additional tests on every material lot



+ 5 weitere Tests bei jeder Materialcharge

hanging hole for easy storage or inserting lever

Querloch: Zum Aufhängen der Werkzeuge oder zum Einstecken eines Hebels

Handle 30% slimmer!
Griff 30% schlanker!

ERGONIC® (pat.)
 U.S. Patent No 7,877,843
Eslim

Ergonic, the first handle that adapts to the user's hand!

Ergonic, der erste Griff, der sich der Hand anpasst!



Insulation up to 50% slimmer!
Isolierung bis zu 50% schlanker!

made in Germany

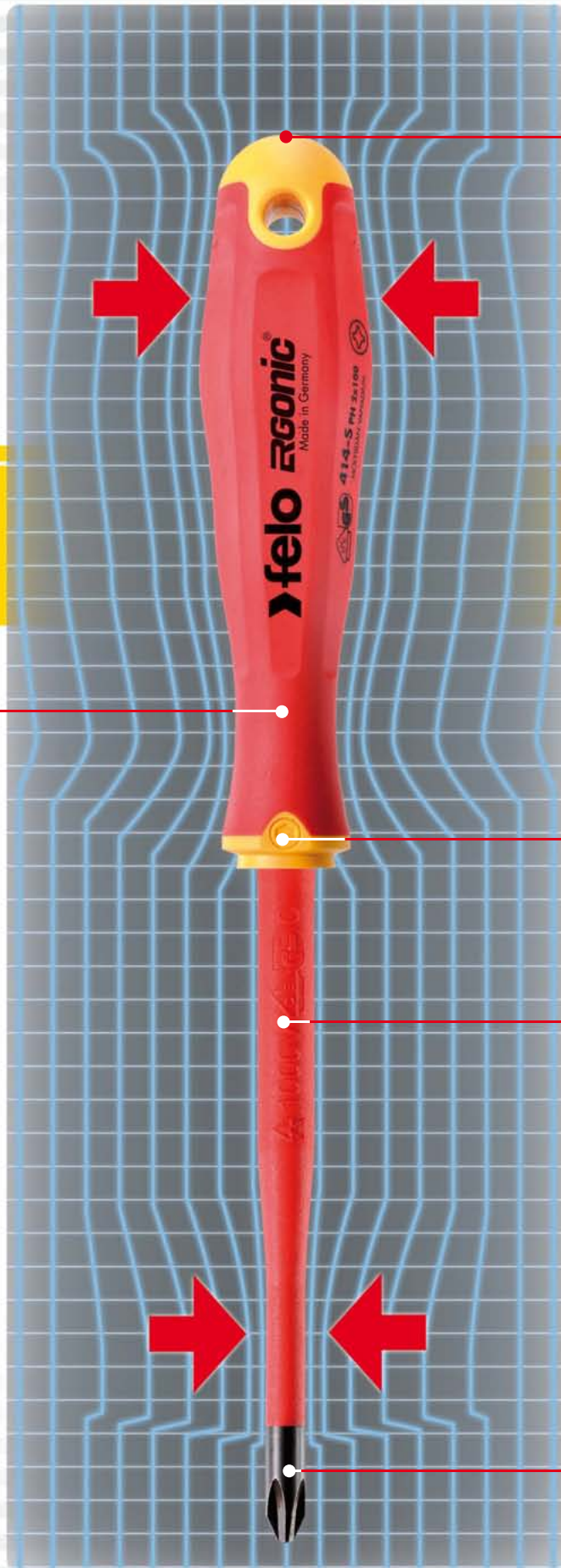

screw symbols on handle cap

Schraubensymbole auf Griffkappe

extra long handle

extra langer Griff



**AC 1000V
 IEC 60900 : 2012**



anti-roll handle design

Abrollschutz

blades manufactured from chrome-molybdenum-vanadium steel

Klingen aus spezieller Chrom-Molybdän-Vanadium-Legierung



EAN code on every product

EAN-Code auf jedem Werkzeug

black tip for precision fit

Black-Tip zur Erhaltung der Präzision und Passgenauigkeit

413



AC 1000V
IEC 60900 : 2012



						Item No		EAN-Code
3,0 x 0,5	100	105	25	3,5	12	413 930 90	45	40 07157 62631 8
3,5 x 0,6	100	105	25	3,5	12	413 935 90	45	40 07157 62635 6
3,5 x 0,8	100	105	25	3,5	12	413 938 90	45	40 07157 62637 0
4,0 x 0,8	100	105	25	4,0	12	413 940 90	46	40 07157 62639 4
4,5 x 1,0	125	115	27	4,5	12	413 945 90	62	40 07157 62641 7
5,5 x 1,0	125	115	27	5,5	12	413 955 90	73	40 07157 62643 1
6,5 x 1,2	125	115	27	6,5	12	413 965 90	86	40 07157 62645 5

414



AC 1000V
IEC 60900 : 2012



PH						Item No		EAN-Code
1	80	105	25	4,5	12	414 192 90	45	40 07157 62647 9
2	100	115	27	6,0	12	414 293 90	73	40 07157 62649 3

415



AC 1000V
IEC 60900 : 2012



PZ						Item No		EAN-Code
1	80	105	25	4,5	12	415 192 90	44	40 07157 62651 6
2	100	115	27	6,0	12	415 293 90	73	40 07157 62653 0

416



For terminal block screws



AC 1000V
IEC 60900 : 2012

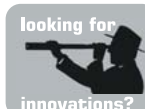

PlusMinus						Item No		EAN-Code
H 1	80	105	25	4,5	12	416 192 90	45	40 07157 62655 4
H 2	100	115	27	6,0	12	416 293 90	73	40 07157 62657 8

417



For terminal block screws



AC 1000V
IEC 60900 : 2012

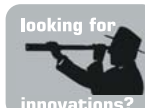

PlusMinus						Item No		EAN-Code
Z 1	80	105	25	4,5	12	417 192 90	45	40 07157 62659 2
Z 2	100	115	27	6,0	12	417 293 90	73	40 07157 62661 5

418



AC 1000V
IEC 60900 : 2012



Torx®	↔	↔	↔	∅	📦	Item No	📦	EAN-Code
10	100	105	25	3,5	12	418 109 90	46	40 07157 62663 9
15	100	105	25	3,5	12	418 159 90	46	40 07157 62665 3
20	125	115	27	4,5	12	418 209 90	62	40 07157 62667 7
25	125	115	27	4,5	12	418 259 90	63	40 07157 62669 1

419



AC 1000V
IEC 60900 : 2012



SQ	↔	↔	↔	∅	📦	Item No	📦	EAN-Code
1 (1,75 mm)	100	105	25	4,5	12	419 190 90	46	40 07157 63167 1
2 (2,30 mm)	125	115	27	4,5	12	419 290 90	62	40 07157 63169 5

413



AC 1000V
IEC 60900 : 2012



Item No	📦	EAN-Code
E-slim set 4 pcs. VDE / E-SLIM Satz 4-tlg.	321	40 07157 62741 4
(2 x) 413: 3,5 x 100 / 5,5 x 125		
(2 x) 414: PH1 x 80 / PH2 x 100		

413



AC 1000V
IEC 60900 : 2012



Item No	📦	EAN-Code
E-slim set 5 pcs. VDE / E-SLIM Satz 5-tlg.	359	40 07157 62853 4
(2 x) 413: 3,5 x 100 / 5,5 x 125		
(2 x) 414: PH1 x 80 / PH2 x 100		
361: Mains testing screwdriver VDE 0680/6, 220-250 Volt		

413



AC 1000V
IEC 60900 : 2012



Item No



EAN-Code

E-slim set 5 pcs. VDE / E-SLIM Satz 5-tlg.

413 851 98

371

40 07157 62743 8

(3 x) **413:** 3,0 x 100 / 4,0 x 100 / 5,5 x 125

(2 x) **414:** PH1 x 80 / PH2 x 100

413



AC 1000V
IEC 60900 : 2012



Item No



EAN-Code

E-slim toolcase 7 pcs. VDE / Koffer 6-tlg. VDE

413 807 36

650

40 07157 62745 2

(3 x) **413:** 3,0 x 100 / 4,0 x 100 / 5,5 x 125

(2 x) **414:** PH1 x 80 / PH2 x 100

415: PZ2 x 100

361: Mains testing screwdriver VDE 0680/6, 220-250 Volt



AC 1000V
IEC 60900 : 2012



413



	Item No		EAN-Code
E-slim XL-Rack 10-pcs VDE / XL Rack 10 tlg. VDE	413 910 93	1212	40 07157 63627 0
(4 x) 413:	3,0 x 100 / 3,5 x 100 / 4,0 x 100 / 5,5 x 125		
(2 x) 414:	PH 1 x 80 / PH 2 x 100		
(1 x) 415:	PZ 2 x 100		
(2 x) 418:	Torx® 15 x 100 / Torx® 20 x 125		
(1 x) 361:	Mains testing screwdriver / Profi-Spannungsprüfer VDE 0680 150 V - 250 V		
(1 x)	Steel Rack / Werkzeuhalter (Stahl)		



Sets not included.
Ohne Sätze

AC 1000V
IEC 60900 : 2012



413



	Item No		EAN-Code
E-slim Kombi Display 22 pcs. VDE	413 881 90	2471	40 07157 62749 0
(4 x 3) 413:	3,0 x 100 / 3,5 x 100 / 4,0 x 100 / 5,5 x 125		
(2 x) 413:	6,5 x 125		
(2 x) 414:	PH1 x 80		
(3 x) 414:	PH2 x 100		
(3 x) 415:	PZ2 x 100		

The Original *Das Original* VDE Serie 500

The leaders in • handle-design • blade quality
• 2-component-technology

Führend in • Design und Ergonomie

• Klingenqualität • 2Komponentengriff-Technik

513



AC 1000V
IEC 60900 : 2012

							Item No		EAN-Code
2,5 x 0,4	75	68	20	2,5	12		513 025 90	16	40 07157 22141 4
3,0 x 0,5	100	68	20	3,0	12		513 030 90	20	40 07157 22113 1
3,5 x 0,6	100	80	25	3,5	12		513 035 90	34	40 07157 22114 8
4,0 x 0,8	100	80	25	3,5	12		513 040 90	34	40 07157 22115 5
4,5 x 1,0	125	99	34	4,5	12		513 045 90	77	40 07157 50124 0
5,5 x 1,0	125	99	34	4,5	12		513 055 90	72	40 07157 22116 2
6,5 x 1,2	150	99	34	5,5	6		513 065 90	89	40 07157 22117 9
8,0 x 1,2	175	105	39	7,0	6		513 080 90	136	40 07157 22118 6

514



AC 1000V
IEC 60900 : 2012

PH							Item No		EAN-Code
0	60	80	25	3,0	12		514 001 90	28	40 07157 22142 1
1	80	90	29	4,5	12		514 102 90	49	40 07157 22119 3
2	100	99	34	6,0	12		514 203 90	83	40 07157 22120 9
3	150	105	39	8,0	6		514 304 90	145	40 07157 22143 8

515



AC 1000V
IEC 60900 : 2012

PZ							Item No		EAN-Code
1	80	90	29	4,5	12		515 102 90	49	40 07157 22121 6
2	100	99	34	6,0	12		515 203 90	83	40 07157 22122 3
3	150	105	39	8,0	6		515 304 90	147	40 07157 22144 5

518



Bitholder					Item No		EAN-Code
1/4"	105	99	34	6	518 125 90	107	40 07157 50785 3

020



Item No



EAN-Code

E-Pro 11+1 pcs / 11+1 tlg	6	020 912 06	220	40 07157 51427 1
(1 x) 518:	1/4" x 105			
(4 x) 020:	3,0 x 0,5 / 4,0 x 0,8 / 5,5 x 1,0 / 7,0 x 1,2			
(2 x) 021:	PZ 1 / PZ 2			
(3 x) 022:	PH 0 / PH 1 / PH 2			
(2 x) 026:	Torx® 20 / Torx® 15			

513



AC 1000V
IEC 60900 : 2012

Item No



EAN-Code

Set 6-pcs / Satz 6-tlg		513 961 97	490	40 07157 50176 9
(4 x) 513:	3,0 x 100 / 3,5 x 100 / 4,0 x 100 / 5,5 x 125			
(2 x) 514:	PH 1 x 80 / PH 2 x 100			

513



AC 1000V
IEC 60900 : 2012

Item No



EAN-Code

Set 6-pcs / Satz 6-tlg		513 961 98	487	40 07157 50120 2
(3 x) 513:	3,5 x 100 / 4,0 x 100 / 5,5 x 125			
(2 x) 514:	PH 1 x 80 / PH 2 x 100			
(1 x) 361:	Mains testing screwdriver / Spannungsprüfer VDE 0680/6, 220-250 Volt			



AC 1000V
IEC 60900 : 2012

513



	Item No		EAN-Code
Set 5-pcs / Satz 5-tlg	513 951 98	360	40 07157 22136 0
[4 x] 513:	3,0 x 100 / 3,5 x 100 / 4,0 x 100 / 5,5 x 125		
[1 x] 515:	PZ 2 x 100		



AC 1000V
IEC 60900 : 2012

513



	Item No		EAN-Code
Set 5-pcs / Satz 5-tlg	513 956 98	400	40 07157 32074 2
[3 x] 513:	2,5 x 75 / 3,0 x 100 / 4,0 x 100		
[2 x] 514:	PH 1 x 80 / PH 2 x 100		



AC 1000V
IEC 60900 : 2012

513



	Item No		EAN-Code
Set 3-pcs / Satz 3-tlg	513 931 14	236	40 07157 52235 1
[2 x] 513:	4,0 x 100 / 5,5 x 125		
[1 x] 514:	PH 2 x 100		

VDE Serie 600

High quality and comprehensive range

Überragend in Qualität,
Preis und Vielfalt



AC 1000V
IEC 60900 : 2012

613



							Item No		EAN-Code
2,5 x 0,4	75	75	23	2,5	12		613 025 90	20	40 07157 10134 1
3,0 x 0,5	100	75	23	3,0	12		613 030 90	24	40 07157 10137 2
3,5 x 0,6	100	80	25	3,5	12		613 035 90	30	40 07157 10139 6
4,0 x 0,8	100	90	29	3,5	12		613 040 90	40	40 07157 10141 9
5,5 x 1,0	125	99	34	4,5	12		613 055 90	64	40 07157 10143 3
6,5 x 1,2	150	99	34	5,5	6		613 065 90	81	40 07157 10146 4
8,0 x 1,2	175	105	39	7,0	6		613 080 90	126	40 07157 10147 1
8,0 x 1,6	200	105	39	7,0	6		613 090 90	136	40 07157 10148 8
10,0 x 1,6	200	115	42	8,0	6		613 100 90	182	40 07157 10149 5



AC 1000V
IEC 60900 : 2012

614



PH							Item No		EAN-Code
0	60	80	25	3,0	12		614 001 90	21	40 07157 24001 9
1	80	90	29	5,0	12		614 102 90	44	40 07157 10150 1
2	100	99	34	6,0	12		614 203 90	75	40 07157 10153 2
3	150	105	39	8,0	6		614 304 90	135	40 07157 10156 3



AC 1000V
IEC 60900 : 2012

615



PZ							Item No		EAN-Code
0	60	80	25	3,0	12		615 001 90	21	40 07157 24008 8
1	80	90	29	5,0	12		615 102 90	44	40 07157 24009 5
2	100	99	34	6,0	12		615 203 90	75	40 07157 24010 1
3	150	105	39	8,0	6		615 304 90	138	40 07157 24011 8



AC 1000V
IEC 60900 : 2012

613



	Item No		EAN-Code
Set 7-pcs / Satz 7-tlg	613 973 97	504	40 07157 51401 1
[5 x] 613: 2,5 x 75 / 3,0 x 100 / 3,5 x 100 / 4,0 x 100 / 5,5 x 125			
[2 x] 614: PH 1 x 80 / PH 2 x 100			



AC 1000V
IEC 60900 : 2012

613



	Item No		EAN-Code
Set 7-pcs / Satz 7-tlg	613 974 97	558	40 07157 51403 5
[3 x] 613: 2,5 x 75 / 4,0 x 100 / 5,5 x 125			
[2 x] 614: PH 1 x 80 / PH 2 x 100			
[2 x] 615: PZ 1 x 80 / PZ 2 x 100			



AC 1000V
IEC 60900 : 2012

613



	Item No		EAN-Code
Set 6-pcs / Satz 6-tlg	613 962 98	362	40 07157 51405 9
(3 x) 613: 2,5 x 75 / 4,0 x 100 / 5,5 x 125			
(2 x) 614: PH 1 x 80 / PH 2 x 100			
(1 x) 361: Mains testing screwdriver / Spannungsprüfer VDE 0680/6, 220-250 Volt			



AC 1000V
IEC 60900 : 2012

613



	Item No		EAN-Code
Set 10-pcs / IEC Koffer 10-tlg.	600 110 96	912	40 07157 10021 4
(7 x) 613: 2,5 x 75 / 3,0 x 100 / 3,5 x 100 / 4,0 x 100 5,5 x 125 / 6,5 x 150 / 8,0 x 175			
(2 x) 614: PH 1 x 80 / PH 2 x 100			
(1 x) 361: Mains testing screwdriver / Spannungsprüfer VDE 0680/6, 220-250 Volt			

VDE Mains testing screwdriver / *Spannungsprüfer*

361



Item No



EAN-Code

Mains testing screwdriver / *Profi-Spannungsprüfer* VDE 0680 150 V - 250 V



3,0 x 0,8 70 mm 23 mm 12 **361 400 00** 30 40 07157 52701 1



361



Item No



EAN-Code

Mains testing screwdriver / *Profi-Spannungsprüfer* VDE 0680 150 V - 250 V on card / *auf Karte*



3,0 x 0,8 70 mm 23 mm 12 **361 400 01** 43 40 07157 53229 9

Safety tools without compromises. Designed and made in Germany.

Sicherheitswerkzeuge ohne Kompromisse. Konstruiert und hergestellt in Deutschland.



361

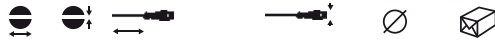

Item No



EAN-Code

Mains testing screwdriver / Spannungsprüfer VDE 0680 220 V - 250 V

3,0 x 0,8 65 mm 13 mm 12 **361 300 00** 17 40 07157 26509 8

dto. on card / auf Karte 12 **361 300 01** 27 40 07157 26510 4

361



Item No



EAN-Code

Mains testing screwdriver / Spannungsprüfer VDE 0680 220 V - 250 V

3,5 x 1,0 100 mm 17 mm 12 **361 350 00** 30 40 07157 26512 8

dto. on card / auf Karte 12 **361 350 01** 43 40 07157 26513 5

361



Item No



EAN-Code

Mains testing screwdriver / Profi-Spannungsprüfer VDE 0680 150 V - 250 V

3,0 x 0,8 150 mm 25 mm 12 **361 600 00** 30 40 07157 31069 9

dto. in pouch / in Tasche 12 **361 600 04** 41 40 07157 52743 1

361



Item No



EAN-Code

Mains testing screwdriver / Profi-Spannungsprüfer VDE 0680 150 V - 250 V

3,5 x 1,0 190 mm 25 mm 12 **361 700 00** 37 40 07157 31070 5

dto. in pouch / in Tasche 12 **361 700 04** 50 40 07157 52745 5

363



Item No



EAN-Code

Autolichtprüfer 6 V bis 24 V

on card / auf Karte

105 mm x 12 mm 12 **363 100 05** 66 40 07157 57551 7

Wire Stripping Tools / Abisolierwerkzeug

Superior quality
for professionals

**made in
Germany**



583

Automatic Wire Stripper /
Automatische Abisolierzange

6

Item No

583 999 11



119

EAN-Code

40 07157 62681 3



8 - 28 mm Ø
5/16" - 1.1/8" Ø

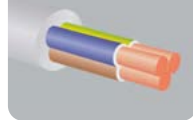

TiN



584

Cable Stripper / Kabelmesser



12

Item No

584 018 11



96

EAN-Code

40 07157 62683 7

VDE Pliers / VDE Zangen

Safety Tools Made in Germany.
Sicherheitswerkzeuge Made in Germany.

   **AC 1000V**
IEC 60900 : 2012

**made in
Germany**

Neu!

580



Item No

AC 1000V
IEC 60900 : 2012



EAN-Code

160 mm Combination Pliers VDE/ Kombizange VDE 6

580 016 40

180

40 07157 63791 8

180 mm Combination Pliers VDE/ Kombizange VDE 6

580 018 40

250

40 07157 63793 2

Neu!

581



Item No

AC 1000V
IEC 60900 : 2012



EAN-Code

160 mm Diagonal Nippers VDE/ Seitenschneider 6

581 016 40

210

40 07157 63795 6

180 mm Diagonal Nippers VDE/ Seitenschneider 6

581 018 40

240

40 07157 63797 0

Neu!

582



Item No

AC 1000V
IEC 60900 : 2012

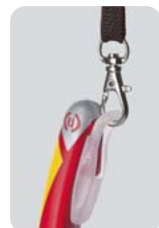

EAN-Code

170 mm Chain Nose Radio Pliers VDE 6

582 017 40

150

40 07157 63799 4

170 mm Telefonzange VDE (Flachrundzange)

Neu!

582



Item No

AC 1000V
IEC 60900 : 2012

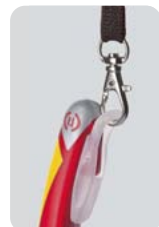

EAN-Code

Chain Nose Radio Pliers VDE curved 45° VDE 6

582 225 40

200

40 07157 63801 4

Telefonzange VDE 45° gebogen

Neu!
583



160 mm Insulation Stripping Pliers

6

Item No

583 016 40

**AC 1000V
IEC 60900 : 2012**



180

EAN-Code

40 07157 63803 8

160 mm Abisolierzange



Neu!
584



Cable Cutter VDE / Kabelschneider VDE

6

Item No

584 016 40

**AC 1000V
IEC 60900 : 2012**



305

EAN-Code

40 07157 63805 2

Kraftseitenschneider VDE



Neu!
581



Heavy Duty Diagonal Nippers VDE /

6

Item No

581 020 40

**AC 1000V
IEC 60900 : 2012**



305

EAN-Code

40 07157 63807 6

Kraftseitenschneider VDE



Neu!
586



Multi Cutter VDE /

6

Item No

586 018 40

**AC 1000V
IEC 60900 : 2012**



305

EAN-Code

40 07157 63811 3

Multifunktionale Abisolierzange VDE



Neu!
580



Safety lanyard with SystemClip /

5

Item No

580 001 00



10

EAN-Code

40 07157 63851 9

Sicherungsband mit SystemClip



VDE tool sets: perfect equipment for professionals.

VDE Werkzeugsätze: die perfekte Ausrüstung für den Profi

Neu!

413



AC 1000V
IEC 60900 : 2012

	Item No		EAN-Code
VDE Service Kit ERGONIC 11-pcs / Werkzeugtasche VDE11-tlg.	413 911 04	1580	40 07157 63855 7
(3 x) 413:	3,5 x 0,6 / 4,0 x 100 / 5,5 x 1,0		
(3 x) 414:	PH 0 x 60 / PH 1 x 80 / PH 2 x 100		
(1 x)	Mains testing Screwdriver / Spannungsprüfer 3,0 mm x 70 mm (VDE 0680/6, 150-250 Volt)		
(1 x)	Combination Pliers / Kombizange 180 mm		
(1 x)	Diagonal Nippers / Seitenschneider 160 mm		
(1 x)	Chain Nose Radio Pliers VDE / Telefonzange VDE (Flachrundzange) 170 mm		
(1 x)	Cable Stripper / Kabelmesser		
	Nylon bag / Nylon Tasche 330 x 270 x 55 mm		

Neu!

413



AC 1000V
IEC 60900 : 2012

	Item No		EAN-Code
VDE Service Kit E-slim 11-pcs / Werkzeugtasche VDE E-Slim 11-tlg.	413 811 04	1615	40 07157 63857 1
(3 x) 413:	3,5 x 0,6 / 4,0 x 100 / 5,5 x 1,0		
(2 x) 414:	PH 1 x 80 / PH 2 x 100		
(1 x) 415:	PZ 2 x 100		
(1 x)	Mains testing Screwdriver / Spannungsprüfer 3,0 mm x 70 mm (VDE 0680/6, 150-250 Volt)		
(1 x)	Combination Pliers / Kombizange 180 mm		
(1 x)	Diagonal Nippers / Seitenschneider 160 mm		
(1 x)	Chain Nose Radio Pliers VDE / Telefonzange VDE (Flachrundzange) 170 mm		
(1 x)	Cable Stripper / Kabelmesser		
	Nylon bag / Nylon Tasche 330 x 270 x 55 mm		

Neu!

413



AC 1000V
IEC 60900 : 2012



EAN-Code

1040 40 07157 63859 5



	Item No		EAN-Code
VDE Belt Pouch 9-pcs / VDE Gürteltasche 9-tlg.	413 995 04		
(3 x) 413: 3,5 x 0,6 / 4,0 x 0,8 / 5,5 x 1,0			
(2 x) 414: PH 1 x 80 / PH 2 x 100			
(1 x) Mains testing Screwdriver / Spannungsprüfer 3,0 mm x 70 mm (VDE 0680/6, 150–250 Volt)			
(1 x) Combination Pliers / Kombizange 180 mm			
(1 x) Diagonal Nippers / Seitenschneider 160 mm			
(1 x) Cable Stripper / Kabelmesser			
Nylon bag / Nylon Tasche 290x 250 x 20 mm			

Neu!

413



AC 1000V
IEC 60900 : 2012



EAN-Code

1070 40 07157 63853 3



	Item No		EAN-Code
XL Tool set VDE with pliers and screwdrivers 8-pcs /	413 985 17		
<i>XL Werkzeugsatz VDE mit Zangen und Schraubendrehern 8-tlg.</i>			
(3 x) 413: 3,5 x 0,6 / 4,0 x 0,8 / 5,5 x 1,0			
(2 x) 414: PH 0 x 60 / PH 1 x 80 / PH 2 x 100			
(1 x) 580: Combination Pliers / Kombizange 180 mm			
(1 x) 581: Diagonal Nippers / Seitenschneider 160 mm			

each handle individually calibrated and certified

jeder Griff individuell kalibriert (mit Zertifikat)

coloured ring indicating torque range

Farbring zur Identifikation des Drehmomentbereiches

0,6 - 1,5 Nm 1,5 - 3,0 Nm 3,0 - 5,4 Nm



easy adjustment of torque

einfaches Einstellen des Drehmoments



Torque screwdrivers with precise adjustment

Serie Nm (pat.)

Präzise einstellbare Drehmoment-Schraubendreher

ergonomically refined design

ergonomisch ausgereiftes Design

blades manufactured from chrome-molybdenum-vanadium steel

Klingen aus spezieller Chrom-Molybdän-Vanadium-Legierung

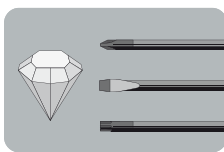

superior torque which exceeds DIN and ISO requirements by up to 100%

Beste Leistungsdaten, bis zu 100% über DIN-Werten

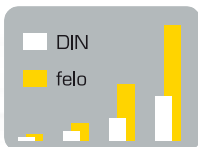

Precise release - indicated by acoustic and mechanic signals

Präzise Auslösung - deutlich spür- und hörbar - bei Erreichen des eingestellten Drehmomentes

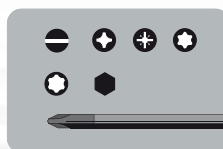

black tip for precision fit

Black-Tip für präzise Passung

exchangeable blades for greatest flexibility in all areas of use

Wechselklingen für höchste Flexibilität in allen Anwendungsbereichen



adjusted torque

eingestelltes Drehmoment 0,6 - 5,4 Nm

loosening torque

Lösemoment 100%

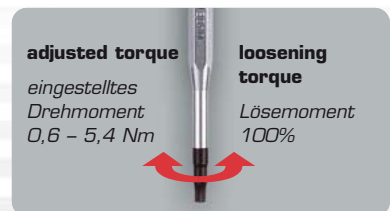



100



1/4"

		Item No		EAN-Code
	Nm-Box 0,6 Nm - 1,5 Nm 14-pcs / Satz 14-tlg	100 991 16	1190	40 07157 52039 5
[12 x]	Torx® 6 / Torx® 7 / Torx® 8 IP 6 / IP 7 / IP 8 / IP 9 3,0 x 0,5 / 3,5 x 0,6 PH 0 PZ 0			
	Magnetic Bitholder / Magnethalter			
[1 x]	Handle / Griff 0,6 Nm - 1,5 Nm Adjustment Tool / Einstellschlüssel			
	Metal Case / Metallbox: 220 mm / 110 mm / 35 mm			



100



1/4"

		Item No		EAN-Code
	Nm-Box 1,5 Nm - 3,0 Nm 14-pcs / Satz 14-tlg	100 992 16	1201	40 07157 52041 8
[12 x]	Torx® 9 / Torx® 10 / Torx® 15 IP 9 / IP 10 / IP 15 4,0 x 0,8 PH 1 / PH 2 PZ 1 / PZ 2			
	Magnetic Bitholder / Magnethalter			
[1 x]	Handle / Griff 1,5 Nm - 3,0 Nm Adjustment Tool / Einstellschlüssel			
	Metal Case / Metallbox: 220 mm / 110 mm / 35 mm			

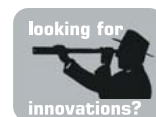

100



1/4"

		Item No		EAN-Code
Nm-Box 3,0 Nm - 5,4 Nm 14-pcs / Satz 14-tlg		100 993 16	1296	40 07157 52043 2
(12 x)	Torx® 15 / Torx® 20 / Torx® 25			
	IP 9 / IP 10 / IP 15			
	4,0 x 0,8			
	PH 1 / PH 2			
	PZ 1 / PZ 2			
	Magnetic Bitholder / Magnethalter			
(1 x)	Handle / Griff 3,0 Nm - 5,4 Nm			
	Adjustment Tool / Einstellschlüssel			
	Metal Case / Metallbox: 220 mm / 110 mm / 35 mm			

100



Handle / Griff	Nm max				Item No		EAN-Code
0,6 - 1,5 Nm		105	32	1	100 001 06	183	40 07157 52149 1

100



Handle / Griff	Nm max				Item No		EAN-Code
1,5 - 3,0 Nm		105	32	1	100 002 06	183	40 07157 52151 4

100



Handle / Griff	Nm max				Item No		EAN-Code
3,0 - 5,4 Nm		105	32	1	100 003 06	192	40 07157 52153 8

197



Item No		EAN-Code
197 170 04	56	40 07157 62395 9

1/4"

1/4" Adapter	170	1/4"	1
--------------	-----	------	---

100



Item No		EAN-Code
100 006 00	2	40 07157 53413 2

Torque-Seal / Verschluß-Siegel	1
--------------------------------	---

Einstellschlüssel 6mm / Einstellschlüssel	27	40 07157 52155 2
---	----	------------------

108



		Nm max			Item No		EAN-Code
	Torx® 6	170	Green	1/4"	108 061 04	43	40 07157 51991 7
	Torx® 7	170	Green	1/4"	108 071 04	43	40 07157 51993 1
	Torx® 8	170	Green/Blue	1/4"	108 083 04	43	40 07157 51995 5
	Torx® 9	170	Green/Blue	1/4"	108 093 04	43	40 07157 51997 9
	Torx® 10	170	Green/Blue	1/4"	108 103 04	43	40 07157 51999 3
	Torx® 15	170	Green/Blue/Red	1/4"	108 153 04	44	40 07157 52001 2
	Torx® 20	170	Green/Blue/Red	1/4"	108 203 04	45	40 07157 52003 6
	Torx® 25	170	Green/Blue/Red	1/4"	108 253 04	46	40 07157 52005 0
	IP 6	170	Green	1/4"	109 061 04	43	40 07157 52007 4
	IP 7	170	Green/Blue	1/4"	109 071 04	43	40 07157 52009 8
	IP 8	170	Green/Blue	1/4"	109 083 04	43	40 07157 52011 1
	IP 9	170	Green/Blue/Red	1/4"	109 093 04	43	40 07157 52013 5
	IP 10	170	Green/Blue/Red	1/4"	109 103 04	43	40 07157 52015 9
	IP 15	170	Green/Blue/Red	1/4"	109 153 04	44	40 07157 52017 3
	IP 20	170	Green/Blue/Red	1/4"	109 203 04	44	40 07157 53791 1
	IP 25	170	Green/Blue/Red	1/4"	109 253 04	44	40 07157 57833 4
	3,0 x 0,5	170	Green	1/4"	100 032 04	43	40 07157 52019 7
	3,5 x 0,6	170	Green/Blue	1/4"	100 353 04	44	40 07157 52021 0
	4,0 x 0,8	170	Green/Blue	1/4"	100 043 04	44	40 07157 52023 4
	5,5 x 1,0	170	Green/Blue/Red	1/4"	100 554 04	45	40 07157 61245 8
	PH 0	170	Green	1/4"	102 001 04	43	40 07157 52025 8
	PH 1	170	Green/Blue	1/4"	102 102 04	45	40 07157 52027 2
	PH 2	170	Green/Blue/Red	1/4"	102 203 04	46	40 07157 52029 6
	PZ 0	170	Green	1/4"	101 001 04	43	40 07157 52031 9
	PZ 1	170	Green/Blue	1/4"	101 102 04	45	40 07157 52033 3
	PZ 2	170	Green/Blue/Red	1/4"	101 203 04	47	40 07157 52035 7
	H 1 (+/-)	170	Green/Blue	1/4"	106 102 04	45	40 07157 61247 2
	H 2 (+/-)	170	Green/Blue/Red	1/4"	106 203 04	47	40 07157 61249 6
	Z 1 (+/-)	170	Green/Blue	1/4"	107 102 04	45	40 07157 57807 5
	Z 2 (+/-)	170	Green/Blue/Red	1/4"	107 203 04	47	40 07157 57809 9
	1,5mm	170	Green	1/4"	104 015 04	43	40 07157 61625 8
	2mm	170	Green	1/4"	104 020 04	43	40 07157 61627 2
	2,5mm	170	Green/Blue	1/4"	104 025 04	43	40 07157 61629 6
	3mm	170	Green/Blue/Red	1/4"	104 030 04	44	40 07157 61631 9
	4mm	170	Green/Blue/Red	1/4"	104 040 04	44	40 07157 61633 3
	Bitholder	170	Green/Blue/Red	1/4"	118 125 04	65	40 07157 52037 1

1/4"

VDE slim blades for Series Nm

Individually tested according EN 60900:2012

VDE slim Klingen für die Serie Nm
stückgeprüft nach EN 60900:2012



Insulation up to
50% slimmer!
Isolierung bis zu
50% schlanker!



Neu!



AC 1000V
IEC 60900 : 2012



108

	Nm VDE slim		Nm max			Item No		EAN-Code
	3,5 x 0,6	170		1/4"	1	100 353 94	23	40 07157 63865 6
	4,0 x 0,8	170		1/4"	1	100 043 94	24	40 07157 63863 2
	5,5 x 1,0	170		1/4"	1	100 554 94	26	40 07157 63867 0
	PH1	170		1/4"	1	101 102 94	26	40 07157 63869 4
	PH2	170		1/4"	1	101 203 94	31	40 07157 63871 7
	PZ1	170		1/4"	1	102 102 94	26	40 07157 63873 1
	PZ2	170		1/4"	1	102 203 94	31	40 07157 63875 5
	H2 +/-	170		1/4"	1	106 203 94	31	40 07157 63877 9
	Z1 +/-	170		1/4"	1	107 102 94	31	40 07157 63879 3
	Z2 +/-	170		1/4"	1	107 203 94	31	40 07157 63881 6



Incorrectly fastened screws pose a serious safety hazard!

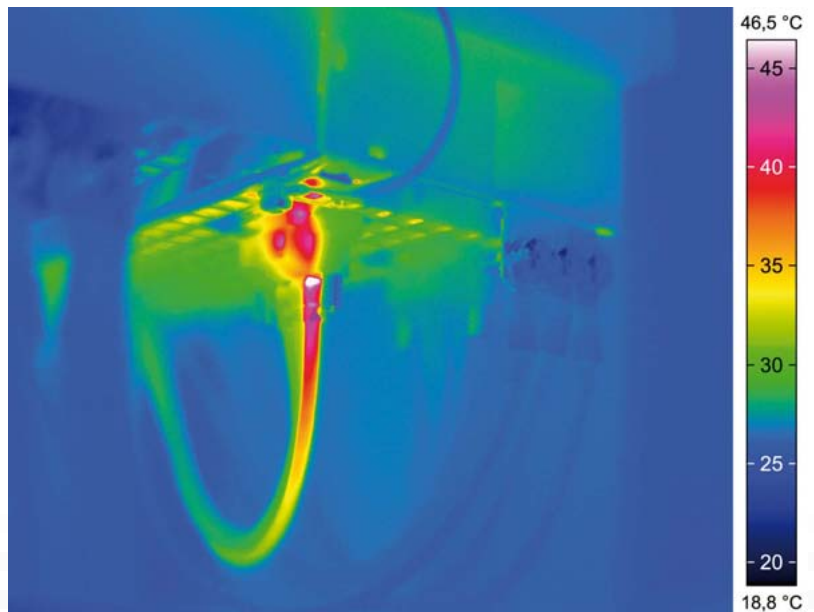

Heavily squeezed wires may result in heat build-up.

freely rotating cap for minimal friction

leicht drehbare, ergonomisch ausgereifte Kappe

hanging hole for easy storage or inserting lever

*Querloch:
Zum Aufhängen der Werkzeuge oder zum Einstecken eines Hebels*



EAN code on every product

EAN-Code auf jedem Werkzeug

felo Precision Screwdrivers are setting the standards in all functional aspects.
Serie 240/250

Felo Präzisions-Schraubendreher setzen Maßstäbe in:
• Funktion • Qualität • Vielfalt
• 2Komponenten-Grifftechnik

pleasant soft grip material for added comfort

angenehm griffiger Weichmantel für ermüdungsfreies Arbeiten

anti-roll handle design

Griffkopf mit Abrollschutz

blades manufactured from chrome-molybdenum-vanadium steel

Klingen aus spezieller Chrom-Molybdän-Vanadium-Legierung

superior torque which exceeds DIN and ISO requirements by up to 100%

beste Leistungsdaten, bis zu 100% über DIN-Werten

ergonomically refined design

ergonomisch ausgereiftes Design

full-length polypropylene core

durchgehender, schlagfester Hartkern



Felo precision screwdrivers are also available in ESD standard.

Felo Präzisions-schraubendreher sind auch in ESD Ausführung erhältlich

ESD Safe
10⁹ - 10¹⁰ Ω

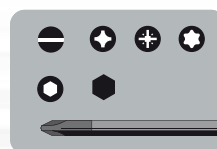

black tip for precision fit

Black-Tip für präzise Passung



240



							Item No		EAN-Code
1,5 x 0,23	60	90	14	2,5	12		240 151 50	20	40 07157 31738 4
2,0 x 0,4	60	90	14	2,5	12		240 201 50	20	40 07157 31740 7
2,5 x 0,4	60	90	14	2,5	12		240 252 50	20	40 07157 31742 1
2,5 x 0,4	150	90	14	2,5	12		240 255 50	24	40 07157 31744 5
2,5 x 0,4	200	90	14	2,5	12		240 257 50	25	40 07157 31746 9
3,0 x 0,5	60	90	14	3,0	12		240 033 50	22	40 07157 31748 3
3,0 x 0,5	100	103	19	3,0	12		240 035 50	24	40 07157 31750 6
3,0 x 0,5	200	103	19	3,0	12		240 037 50	29	40 07157 31752 0
3,5 x 0,6	60	103	19	3,0	12		240 333 50	24	40 07157 61307 3
3,5 x 0,6	100	103	19	3,5	12		240 353 50	26	40 07157 31754 4
3,5 x 0,6	150	103	19	3,5	12		240 355 50	31	40 07157 31756 8
3,5 x 0,6	250	103	19	3,5	12		240 358 50	39	40 07157 31758 2
4,0 x 0,8	100	103	19	4,0	12		240 043 50	30	40 07157 31760 5
4,0 x 0,8	150	103	19	4,0	12		240 045 50	35	40 07157 31762 9
4,0 x 0,8	200	103	19	4,0	12		240 047 50	40	40 07157 31764 3



241

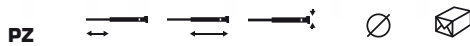

PZ							Item No		EAN-Code
0	60	90	14	3,0	12		241 001 50	19	40 07157 31766 7
1	60	103	19	4,5	12		241 102 50	29	40 07157 31768 1



242

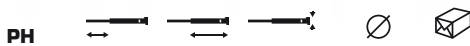

PH							Item No		EAN-Code
000	60	90	14	2,5	12		242 000 50	20	40 07157 31770 4
00	60	90	14	2,5	12		242 009 50	20	40 07157 31772 8
0	60	90	14	3,0	12		242 001 50	21	40 07157 31774 2
1	60	103	19	4,5	12		242 102 50	29	40 07157 31776 6
1	150	103	19	4,5	12		242 105 50	41	40 07157 31778 0

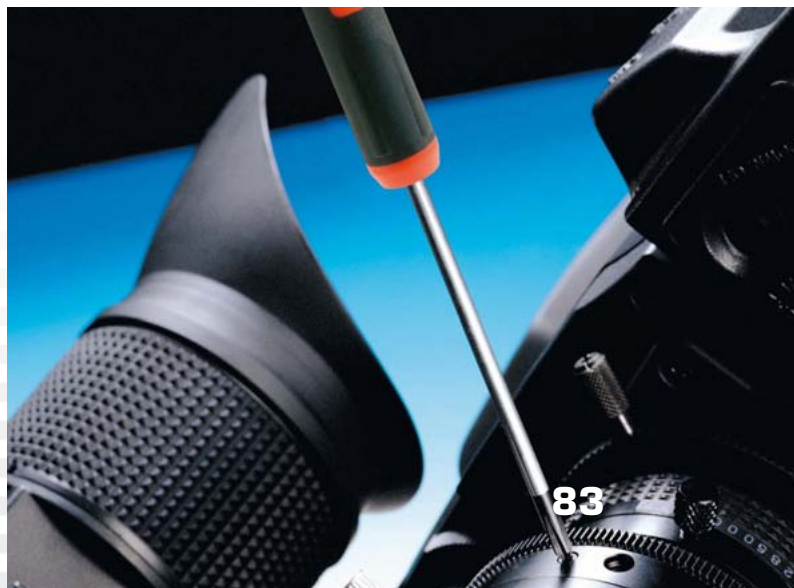
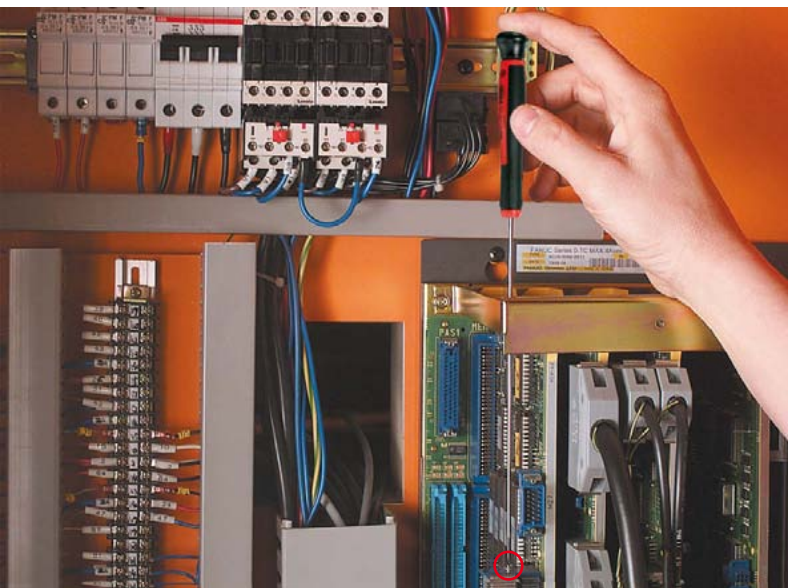

246



mm						Item No		EAN-Code
1,5	60	90	14	1,5	12	246 151 50	17	40 07157 31782 7
2	60	90	14	2,0	12	246 201 50	19	40 07157 31784 1
2,5	75	90	14	2,5	12	246 252 50	21	40 07157 31786 5
3	75	103	19	3,0	12	246 302 50	23	40 07157 31788 9

248



Torx®						Item No		EAN-Code
5	60	90	14	3,0	12	248 051 50	20	40 07157 31790 2
6	60	90	14	3,0	12	248 061 50	20	40 07157 31792 6
7	60	90	14	3,0	12	248 071 50	21	40 07157 31794 0
8	60	90	14	3,0	12	248 081 50	22	40 07157 31796 4
9	60	90	14	3,5	12	248 091 50	22	40 07157 31798 8
10	60	103	19	3,5	12	248 103 50	26	40 07157 31800 8
10	250	103	19	3,5	6	248 108 50	38	40 07157 50276 6
15	100	103	19	4,0	12	248 153 50	30	40 07157 31802 2
15	250	103	19	4,0	6	248 158 50	45	40 07157 50278 0
20	250	103	19	4,0	6	248 208 50	61	40 07157 50280 3

249



mm					Item No		EAN-Code
3	60	103	19		249 300 50	29	40 07157 50709 9
3,5	60	103	19		249 350 50	29	40 07157 50711 2
4	60	103	19		249 400 50	30	40 07157 50713 6
4,5	60	103	19		249 450 50	30	40 07157 50715 0
5	60	103	19		249 500 50	31	40 07157 50717 4
5,5	60	103	19		249 550 50	31	40 07157 50719 8

240**Box 6-pce / Box. 6-tlg.****Item No****EAN-Code****240 961 56**

195

40 07157 31844 2

[4 x] **240:** 1,5 x 60 / 2,0 x 60 / 2,5 x 60 / 3,0 x 60[2 x] **242:** Phillips 00 x 60 / Phillips 0 x 60**Box 6-pce / Box. 6-tlg.****248 961 56**

194

40 07157 31846 6

[4 x] **248:** Torx® 6 x 60 / Torx® 7 x 60 / Torx® 8 x 60 / Torx® 9 x 60[2 x] **246:** 1,5 mm x 60 mm / 2,0 mm x 60 mm**249****Box 6-pce / Box. 6-tlg.****Item No****EAN-Code****249 961 56**

254

40 07157 50721 1

[6 x] **249:** 3,0 mm x 60 mm / 3,5 mm x 60 mm / 4,0 mm x 60 mm /

4,5 mm x 60 mm / 5,0 mm x 60 mm / 5,5 mm x 60 mm

245**Watchmaker Screwdriver Set, 6-pce****Item No****EAN-Code****245 961 06**

300

40 07157 63357 6

Uhrmacher Schraubendreher Satz, 6-tlg.[6 x] **245:** 1,0 / 1,5 / 1,8 / 2,3 / 2,9 / 3,6



280



		Item No		EAN-Code
T4-Box 7-pce / T-Box. 7-tlg.		280 907 06	163	40 07157 50723 5
[6 x]	Blade, Klinge			
	1,5 - 3,0 / 2,0 - 3,5 / 2,5 - 4,0			
	PH 1 - PH 0 / PH 00 - PH 000			
	PZ 1 - PZ 0			
[1 x]	Handle, Griff 102 x 19 mm			
T4-Box 7-pce / T-Box. 7-tlg.		280 907 16	171	40 07157 50725 9
[6 x]	Blade, Klinge			
	1,3 mm - 4,0 mm / 1,5 mm - 2,0 mm / 2,5 mm - 3,0 mm			
	Torx® 6 - Torx® 15 / Torx® 7 - Torx® 10 / Torx® 8 - Torx® 9			
[1 x]	Handle, Griff 102 x 19 mm			
T4-Box 7-pce / T-Box. 7-tlg.		280 907 26	164	40 07157 50727 3
[6 x]	Blade, Klinge			
	2,0 - 3,5			
	PH1 - PH 0 / PH 00 - PH 000			
	Torx® 6 - Torx® 15 / Torx® 7 - Torx® 10 / Torx® 8 - Torx® 9			
[1 x]	Handle, Griff 102 x 19 mm			



280



				Item No		EAN-Code
1,5 x 0,25 - 3,0 x 0,5	110 mm	4 mm	1	280 153 14	16	40 07157 50729 7
2,0 x 0,4 - 3,5 x 0,6	110 mm	4 mm	1	280 235 14	16	40 07157 50731 0
2,5 x 0,4 - 4,0 x 0,8	110 mm	4 mm	1	280 245 14	16	40 07157 50733 4
PH 00 - PH 000	110 mm	4 mm	1	282 000 14	16	40 07157 50737 2
PH 1 - PH 0	110 mm	4 mm	1	282 001 14	16	40 07157 50735 8
PZ 1 - PZ 0	110 mm	4 mm	1	281 010 14	16	40 07157 50739 6
1,3 mm - 4 mm	110 mm	4 mm	1	284 134 14	16	40 07157 50741 9
1,5 mm - 2 mm	110 mm	4 mm	1	284 152 14	16	40 07157 50743 3
2,5 mm - 3 mm	110 mm	4 mm	1	284 253 14	16	40 07157 50745 7
Torx® 6 - Torx® 15	110 mm	4 mm	1	286 615 14	16	40 07157 50747 1
Torx® 7 - Torx® 10	110 mm	4 mm	1	286 710 14	16	40 07157 50749 5
Torx® 8 - Torx® 9	110 mm	4 mm	1	286 890 14	16	40 07157 50751 8

250



ESD Safe
10⁸ - 10¹⁰ Ω





							Item No		EAN-Code
1,5 x 0,23	60	102	19	2,5	12		250 151 80	20	40 07157 31806 0
2,0 x 0,4	60	102	19	2,5	12		250 201 80	21	40 07157 31808 4
2,5 x 0,4	60	102	19	2,5	12		250 252 80	21	40 07157 31810 7
3,0 x 0,5	60	102	19	3,0	12		250 033 80	23	40 07157 31812 1
3,0 x 0,5	100	102	19	3,0	12		250 035 80	24	40 07157 31814 5

252

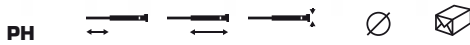

ESD Safe
10⁸ - 10¹⁰ Ω



PH							Item No		EAN-Code
00	60	102	19	2,0	12		252 009 80	20	40 07157 31816 9
0	60	102	19	3,0	12		252 001 80	22	40 07157 31818 3
1	80	102	19	4,5	12		252 102 80	32	40 07157 31820 6

250



ESD Safe
10⁸ - 10¹⁰ Ω



							Item No		EAN-Code
ESD-Box 6-pce / ESD-Box.6-tlg.							250 961 86	202	40 07157 31848 0
(4 x) 250:	1,5 x 60 / 2,0 x 60 / 2,5 x 60 / 3,0 x 60								
(2 x) 252:	Phillips 00 x 60 / Phillips 0 x 60								



telescopic depot for 7 bits
Teleskopmagazin für 7 Bits



ergonomically refined handle design for highest comfort and heavy duty use

ergonomisch ausgereifte Griffgestaltung für höchsten Komfort bei härtestem Einsatz

smooth, seamless handle for maximum comfort

nahtfrei glatte Kappe für minimale Reibung

easy to reach bits safely stored inside the handle

einfach zu öffnendes, versenkbares Depot garantiert sichere Aufbewahrung der Bits

pleasant soft grip material for highest torque

angenehm griffiger Weichmantel für höchste Drehmomente



Allround versatility and advanced ergonomics
Serie 370 (pat.)

Das Optimum an Vielseitigkeit und Ergonomie



Serie 373

with bitholder for power tool

mit Bithalter für Akkuwerkzeug

bitholder with stainless steel sleeve and extremely strong magnet

Bithalter mit Edelstahl-Hülse und extrem starkem Magneten



Serie 374

Magazine handle with ratchet

Magazingriff mit Ratsche

professional reversible ratchet - max. torque >24 Nm

Profi-Umschaltratsche - übertragbares Drehmoment > 24 Nm



Sales displays on page 193

Verkaufsdiskontrollen auf Seite 193



373



		Item No		EAN-Code
Magazine Handle with bitholder for power tool on card	6	373 108 05	160	40 07157 52227 6
<i>Magazingriff mit Bithalter für Akkuwerkzeug auf Karte</i>				
[8 x]	0,6 x 4,5 / 1,0 x 5,5 / 1,2 x 6,5			
	PH 0 / PH 1 / PH 2 / PZ 1 / PZ 2			
Magazine Handle with bitholder for power tool on card	6	373 208 05	161	40 07157 52229 0
<i>Magazingriff mit Bithalter für Akkuwerkzeug auf Karte</i>				
[8 x]	Bits C 6,3 x 25 mm			
	1,0 x 5,5			
	PH 1 / PH 2 / PZ 1 / PZ 2			
	Torx® 15 / Torx® 20 / Torx® 25			

374



		Item No		EAN-Code
[1 x] Magazine Handle with Ratchet on card	6	374 004 05	229	40 07157 52223 8
<i>Magazingriff mit Ratsche auf Karte</i>				
[8 x]	Bits C 6,3 x 25 mm			
	0,6 x 4,5 / 1,0 x 5,5 / 1,2 x 6,5			
	PH 0 / PH 1 / PH 2 / PZ 1 / PZ 2			
[1 x] Magazine Handle with Ratchet on card	6	374 204 05	229	40 07157 52225 2
<i>Magazingriff mit Ratsche auf Karte</i>				
[8 x]	Bits C 6,3 x 25 mm			
	1,0 x 5,5			
	PH 1 / PH 2 / PZ 1 / PZ 2			
	Torx® 15 / Torx® 20 / Torx® 25			

376



		Item No		EAN-Code
[1 x] Magazine Handle Bitholder (long) on card	6	376 041 05	188	40 07157 52221 4
<i>Magazingriff Bithalter (lang) auf Karte</i>				
[8 x]	Bits C 6,3 x 25 mm			
	0,6 x 4,5 / 1,0 x 5,5 / 1,2 x 6,5			
	PH 0 / PH 1 / PH 2 / PZ 1 / PZ 2			
[1 x] Magazine Handle Bitholder (long) on card	6	376 044 05	188	40 07157 52569 7
<i>Magazingriff Bithalter (lang) auf Karte</i>				
[8 x]	Bits C 6,3 x 25 mm			
	1,0 x 5,5			
	PH 1 / PH 2 / PZ 1 / PZ 2			
	Torx® 15 / Torx® 20 / Torx® 25			

ergonomically refined soft grip coating

*angenehm griffiger Weichmantel:
Keine Druckstellen = mehr Kraft*

2-component handle for added comfort

2Komponenten Griff – Ihre Hand sollte es Ihnen wert sein



Made by professionals for professionals

T-Handle / T-Griffe

*Von Profis für Profis:
Qualität, Vielfalt, Funktionalität*

strong, durable core for the highest torque

*Hartkern für dauerhafte
Klingen-Griff-Verbindung auch
bei höchsten Belastungen*

hanging hole for easy storage

*Querloch:
Zum Aufhängen der Werkzeuge.*

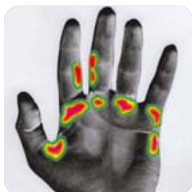

Without soft-grip coating: extreme pressure points

*Ohne Weichmantel:
erhebliche Druckstellen*

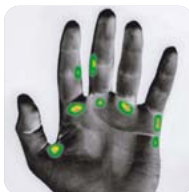

With soft grip coating: reduced pressure points

*Mit Weichmantel:
kaum Druckstellen*

EAN code on every product

*EAN-Code auf jedem
Werkzeug*



GS tested for safety

GS - geprüfte Sicherheit



blades made from chrome-vanadium steel and chrome-molybdenum-vanadium steel

*Klingen aus spezieller
Chrom-Vanadium und
Chrom-Molybdän-Vanadium-Legierung*

matt chrome-plated blades with black tips for precision fit

*matt verchromte Klingen
mit Black-Tip*



superior hardness which exceeds DIN and ISO requirements by up to 100%

*Beste Leistungsdaten,
bis zu 100% über
DIN-Werten*





303



mm					Item No		EAN-Code
2	100	100	2,0	12	303 203 80	58	40 07157 32248 7
2,5	100	100	2,5	12	303 253 80	60	40 07157 32250 0
3	150	100	3,0	8	303 035 80	66	40 07157 32252 4
4	150	100	4,0	8	303 045 80	74	40 07157 32254 8
5	150	100	5,0	8	303 055 80	84	40 07157 32256 2
6	150	100	6,0	8	303 065 80	100	40 07157 32258 6
8	150	100	8,0	8	303 085 80	134	40 07157 32260 9
8	200	100	8,0	8	303 087 80	155	40 07157 32262 3
10	200	100	10,0	8	303 107 80	198	40 07157 32264 7



304



mm				Item No		EAN-Code
5,5	230	100	8	304 558 80	113	40 07157 32266 1
6	125	100	8	304 064 80	94	40 07157 32296 8
6	230	100	8	304 068 80	167	40 07157 32268 5
7	230	100	8	304 078 80	138	40 07157 32270 8
8	125	100	8	304 084 80	109	40 07157 32300 2
8	230	100	8	304 088 80	141	40 07157 32272 2
8	350	100	8	304 089 80	177	40 07157 32274 6
9	230	100	8	304 098 80	142	40 07157 32276 0
10	125	100	8	304 104 80	124	40 07157 32304 0
10	230	100	8	304 108 80	166	40 07157 32278 4
10	350	100	8	304 109 80	213	40 07157 32280 7
11	230	100	8	304 118 80	174	40 07157 32282 1
12	230	100	8	304 128 80	175	40 07157 32284 5
13	125	100	8	304 134 80	138	40 07157 32310 1
13	230	100	8	304 138 80	177	40 07157 32286 9
13	350	100	8	304 139 80	225	40 07157 32288 3
17	230	100	8	304 178 80	202	40 07157 32292 0



308



Torx®					Item No		EAN-Code
10	125	100	3,5	8	308 103 80	64	40 07157 50813 3
15	125	100	4,0	8	308 153 80	68	40 07157 50815 7
20	125	100	5,0	8	308 204 80	78	40 07157 32316 3
20	200	100	5,0	8	308 207 80	88	40 07157 32318 7
25	125	100	5,0	8	308 254 80	78	40 07157 32320 0
25	200	100	5,0	8	308 257 80	89	40 07157 32322 4
27	200	100	5,0	8	308 277 80	88	40 07157 32324 8
30	200	100	6,0	8	308 307 80	106	40 07157 32326 2
40	200	100	8,0	8	308 407 80	142	40 07157 32328 6
45	140	100	8,0	8	308 455 80	124	40 07157 32330 9



397



			Item No		EAN-Code
T-Handle with square adapter / T-Griff mit 4-Kant Adapter					
1/2"	125	100	6	150	40 07157 62897 8
1/4"	125	100	6	103	40 07157 62899 2
3/8"	125	100	6	135	40 07157 62901 2



338



			Item No		EAN-Code
1/4"	125	100	6	111	40 07157 32350 7



Black Tip: 2mm - 5mm

313



mm					Item No		EAN-Code
2	120	60	4,0	5	313 020 00	23	40 07157 60319 7
2,5	120	60	4,0	5	313 025 00	23	40 07157 60323 4
3	140	70	4,0	5	313 030 00	26	40 07157 60325 8
3,5	140	70	6,0	5	313 035 00	26	40 07157 60327 2
4	170	85	6,0	5	313 040 00	66	40 07157 60329 6
4,5	170	85	6,0	5	313 045 00	66	40 07157 60331 9
5	170	85	6,0	5	313 050 00	66	40 07157 60333 3
6	200	100	8,0	5	313 060 00	140	40 07157 60335 7
7	200	100	8,0	5	313 070 00	140	40 07157 60337 1
8	240	120	10,0	5	313 080 00	260	40 07157 60339 5
9	260	135	10,0	5	313 090 00	280	40 07157 60341 8
10	280	145	12,0	5	313 100 00	435	40 07157 60343 2
12	300	155	14,0	5	313 120 00	625	40 07157 60345 6
14	320	165	16,0	5	313 140 00	890	40 07157 60347 0



340



					Item No		EAN-Code
4,0 x 0,8	125 mm		4,0 mm	12	340 040 00	13	40 07157 31018 7
	<i>dto. in pouch / in Tasche</i>				340 040 04	21	40 07157 57555 5
5,5 x 1,0	135 mm		5,5 mm	12	340 055 00	28	40 07157 31019 4
	<i>dto. in pouch / in Tasche</i>				340 055 04	36	40 07157 57559 3
8,0 x 1,2	200 mm		8,0 mm	12	340 080 00	89	40 07157 26004 8
	<i>dto. in pouch / in Tasche</i>				340 080 04	101	40 07157 57793 1
PZ							
1 + 2	135 mm		6,0 mm	12	341 120 00	35	40 07157 26006 2
	<i>dto. in pouch / in Tasche</i>				341 120 04	43	40 07157 57561 6
3 + 4	200 mm		8,0 mm	12	341 340 00	74	40 07157 26008 6
	<i>dto. in pouch / in Tasche</i>				341 340 04	82	40 07157 57565 4
PH							
1 + 2	135 mm		6,0 mm	12	342 120 00	35	40 07157 26010 9
	<i>dto. in pouch / in Tasche</i>				342 120 04	43	40 07157 57563 0
3 + 4	200 mm		8,0 mm	12	342 340 00	94	40 07157 26012 3
	<i>dto. in pouch / in Tasche</i>				342 340 04	106	40 07157 57795 5
PH							
6,0 + PH 2	135 mm		6,0 mm	12	343 260 00	35	40 07157 26014 7
	<i>dto. in pouch / in Tasche</i>				343 260 04	44	40 07157 57557 9

optimal hexagon shape, precision formed

optimal in engen Toleranzen gezogene Sechskant-Profile

virtually indestructible handle

Fast unzerstörbarer, patentierter Griff

made of special American high-torque alloy (Protanium™)

hergestellt aus amerikanischen Speziallegierungen (Protanium™)

30% increased anti-rust protection due to unique coating

durch spezielle Beschichtung bis zu 30% höherer Rostschutz

Sechskant-Schlüssel Hexagon Key Products

Höchste Qualität ohne Kompromiss

Hexagon keys with uncompromisingly high quality

improved ergonomic design to prevent injury

verbesserte Ergonomie verhindert Druckstellen



Blade movement radius of over 270°= timesaver by eliminating the need to exit and reenter the screw

Klingen über 270° klappbar=Zeitersparnis, da kein Umstecken notwendig

precisely machined ballpoint, even on the smallest size

Kugelköpfe präzise gefräst, auch bei kleinen Abmessungen



precision-engineered critical contact areas

Spezielle Geometrie in der kritischen Zone

careful tempering guarantees optimum hardness and elasticity

sorgfältige Vergütung garantiert optimale Härte und Elastizität

Torque exceeding that of leading competitors by up to 20%

Drehmoment bis zu 20% über den führenden Wettbewerbern

matte chrome surface

matt verchromte Oberfläche

QUALITY
Made in USA

extra long arm for maximum leverage

extra lange Ausführung für extra Hebelwirkung

Black-tip for accurate fit

Black-Tip für höchste Passgenauigkeit

348



Torx®					Item No		EAN-Code
5	33	19	2,5	3	348 105 50	3	40 07157 53317 3
6	33	19	2,5	3	348 106 50	3	40 07157 53319 7
7	33	19	2,5	3	348 107 50	4	40 07157 53321 0
8	33	19	2,5	3	348 108 50	4	40 07157 53323 4
9	37	24	3,0	3	348 109 50	5	40 07157 53325 8
10	37	24	3,0	3	348 110 50	6	40 07157 53327 2
15	43	28	4,0	3	348 115 50	8	40 07157 53329 6
20	43	28	4,0	3	348 120 50	11	40 07157 53331 9

349



Torx Plus®					Item No		EAN-Code
IP 5	33	19	2,5	3	349 105 50	3	40 07157 53333 3
IP 6	33	19	2,5	3	349 106 50	3	40 07157 53335 7
IP 7	33	19	2,5	3	349 107 50	4	40 07157 53337 1
IP 8	33	19	2,5	3	349 108 50	4	40 07157 53339 5
IP 9	37	24	3,0	3	349 109 50	5	40 07157 53341 8
IP 10	37	24	3,0	3	349 110 50	6	40 07157 53343 2
IP 15	43	28	4,0	3	349 115 50	8	40 07157 53345 6
IP 20	43	28	4,0	3	349 120 50	11	40 07157 53347 0

348



Torx®					Item No		EAN-Code
set 7 pcs / Satz 7-tlg					348 907 50	71	40 07157 60393 7
[7 x] 348: Torx® 6 / Torx® 7 / Torx® 8 / Torx® 9							
Torx® 10 / Torx® 15 / Torx® 20							



349

Torx Plus®  



Item No



EAN-Code

set 7 pcs / Satz 7-tlg

349 907 50

71

40 07157 60395 1

(7 x) 349: IP 6 / IP 7 / IP 8 / IP 9
IP 10 / IP 15 / IP 20



348

Torx® 



Item No



EAN-Code

				Item No		EAN-Code
6	42	2,5	12	348 006 00	2	40 07157 30742 2
7	48	2,5	12	348 007 00	2	40 07157 30743 9
8	48	2,5	12	348 008 00	2	40 07157 30744 6
9	48	3,0	12	348 009 00	2	40 07157 30745 3
10	86	3,5	12	348 010 00	7	40 07157 26054 3
15	91	3,5	12	348 015 00	8	40 07157 26055 0
20	95	4,0	12	348 020 00	11	40 07157 26056 7
25	100	5,0	12	348 025 00	17	40 07157 26057 4
27	105	6,0	12	348 027 00	27	40 07157 26058 1
30	115	6,0	12	348 030 00	30	40 07157 26059 8
40	124	8,0	12	348 040 00	56	40 07157 26060 4
45	133	8,0	12	348 045 00	61	40 07157 26061 1
50	152	9,0	12	348 050 00	88	40 07157 30746 0
55	172	12,0	12	348 055 00	161	40 07157 30747 7
60	190	13,5	12	348 060 00	248	40 07157 30748 4



348

Set, 8-pcs. / Satz 8 tlg.



Item No



EAN-Code

6

348 888 01

150

40 07157 62533 5

Torx® 09 / Torx® 10 / Torx® 15 / Torx® 20 / Torx® 25 / Torx® 27 / Torx® 30 / Torx® 40

 **QUALITY**
Made in USA



QUALITY
Made in USA

348



TF 8 Fold-Up / Handklapphalter

6

Item No

348 088 01



156

EAN-Code

40 07157 60401 9

Torx® 9 / Torx® 10 / Torx® 15 / Torx® 20 / Torx® 25

Torx® 27 / Torx® 30 / Torx® 40



QUALITY
Made in USA

348



LTX 8 Torx®-Ballpoint Set, 8-pcs.

6

Item No

348 080 01



150

EAN-Code

40 07157 60403 3

Torx®-Kugelkopf Satz 8 tlg.

Torx® 09 / Torx® 10 / Torx® 15 / Torx® 20 / Torx® 25 / Torx® 27 / Torx® 30 / Torx® 40









 **QUALITY**
Made in USA

345







				Item No		EAN-Code
1,5 mm	46,5	1,5	100	345 015 00	1	40 07157 26017 8
2,0 mm	52	2,0	100	345 020 00	2	40 07157 26018 5
2,5 mm	58,5	2,5	100	345 025 00	3	40 07157 26019 2
3,0 mm	66	3,0	100	345 030 00	5	40 07157 26020 8
4,0 mm	74	4,0	100	345 040 00	10	40 07157 26021 5
5,0 mm	85	5,0	100	345 050 00	18	40 07157 26022 2
6,0 mm	96	6,0	50	345 060 00	29	40 07157 26023 9
8,0 mm	108	8,0	50	345 080 00	58	40 07157 26024 6
10,0 mm	122	10,0	25	345 100 00	102	40 07157 26025 3
12,0 mm	137	12,0	10	345 120 00	162	40 07157 26026 0
14,0 mm	154	14,0	10	345 140 00	256	40 07157 26027 7
17,0 mm	177	17,0	5	345 170 00	431	40 07157 26028 4



 **QUALITY**
Made in USA

355



				Item No		EAN-Code
1,5 mm	80	1,5	10	355 015 00	1	40 07157 31022 4
2,0 mm	85	2,0	10	355 020 00	3	40 07157 31023 1
2,5 mm	90	2,5	10	355 025 00	4	40 07157 19082 6
3,0 mm	100	3,0	10	355 030 00	7	40 07157 19083 3
4,0 mm	112	4,0	10	355 040 00	14	40 07157 19084 0
5,0 mm	121	5,0	10	355 050 00	25	40 07157 19085 7
6,0 mm	140	6,0	10	355 060 00	41	40 07157 19086 4
8,0 mm	163	8,0	10	355 080 00	85	40 07157 19087 1
10,0 mm	190	10,0	5	355 100 00	152	40 07157 19088 8

365



QUALITY
Made in USA

				Item No		EAN-Code
1,5 mm	92	1,5	10	365 015 00	2	40 07157 50314 5
2,0 mm	102	2,0	10	365 020 00	3	40 07157 50316 9
2,5 mm	114	2,5	10	365 025 00	5	40 07157 50318 3
3,0 mm	128	3,0	10	365 030 00	9	40 07157 50320 6
4,0 mm	144	4,0	10	365 040 00	18	40 07157 50322 0
5,0 mm	162	5,0	10	365 050 00	32	40 07157 50324 4
6,0 mm	173	6,0	10	365 060 00	49	40 07157 50326 8
8,0 mm	197	8,0	10	365 080 00	99	40 07157 50328 2
10,0 mm	226	10,0	5	365 100 00	178	40 07157 50330 5

365



QUALITY
Made in USA



				Item No		EAN-Code
BLX 9 extra long Set 9-pcs Series 355			6	365 009 01	454	40 07157 60397 5
<i>BLX 9 extra lang Satz 9 tlg. Serie 355</i>						
1,5 mm / 2,0 mm / 2,5 mm / 3,0 mm / 4,0 mm						
5,0 mm / 6,0 mm / 8,0 mm / 10,0 mm						



 **QUALITY**
Made in USA

345





		Item No		EAN-Code
HF 7M Fold-Up / Handklapphalter	6	345 007 01	179	40 07157 60399 9
2,0 mm / 2,5 mm / 3,0 mm / 4,0 mm				
5,0 mm / 6,0 mm / 8,0 mm				



 **QUALITY**
Made in USA

345



		Item No		EAN-Code
BLX 6 Set 6-pcs. Short version, nickel plated	12	345 006 01	64	40 07157 60405 7
<i>BLX 6 Satz 6-tlg. kurze Version, vernickelt</i>				
1,5 mm / 2,0 mm / 2,5 mm / 3,0 mm / 4,0 mm / 5,0 mm				

355



Item No



QUALITY
Made in USA

EAN-Code

BLX 9 Set 9-pcs. Series 355

6

355 009 01

363

40 07157 60407 1

BLX 9 Satz 9-tlg. Serie 355

1,5 mm / 2,0 mm / 2,5 mm / 3,0 mm / 4,0 mm

5,0 mm / 6,0 mm / 8,0 mm / 10,0 mm

355



Item No



QUALITY
Made in USA

EAN-Code

BLX 15 Set 15-pcs. Series 355

6

355 150 01

653

40 07157 60409 5

BLX 15 Satz 15-tlg. Serie 355

1,27 / 1,5 mm / 2,0 mm / 2,5 mm / 3,0 mm / 3,5 mm

4,0 mm / 4,5 mm / 5,0 mm / 5,5 mm / 6,0 mm / 7,0 mm

8,0 mm / 9,0 mm / 10,0 mm

375



Item No



QUALITY
Made in USA

EAN-Code

BLX 13 Set 13-pcs. Inch Sizes

6

375 130 01

399

40 07157 60411 8

BLX 13 Satz 13-tlg. Zoll-Abmessungen

.050 1/16 5/64 3/32 7/64 1/8

9/64 5/32 3/16 7/32 1/4 5/16 3/8



**Extremely strong ratcheting mechanism with super fine-toothing
(>100Nm, 72 teeth, 5° ratcheting angle)**

*extrem starke Umschaltmechanik mit Super-Feinverzahnung
(>100Nm, 72 Zähne, 5°Rückholwinkel)*



**Sockets safely locked
and easily released by push-button**

*Steckschlüssel-Sicherheitsverriegelung
(mit Druckknopfauflösung)*

**Handle inseparably
connected with ratchet**

*Griff unlösbar mit dem
Schmiedeteil verbunden*

**1/4" tool sets with ERGONIC ratchet:
perfect and reliable without compromises**

*1/4 Zoll Werkzeug-Sets mit ERGONIC Ratsche:
perfekt und zuverlässig ohne Kompromisse*

R-GO



EP 1963072

**Patented ERGONIC handle with
cushion effect:
the ultimate of comfort!**

*patentierter ERGONIC Griff
mit Kissen-Effekt:
Mehr Komfort geht nicht!*

**Practice oriented assortments
stored in robust StrongBox**

*Verschiedene anwendungsgerechte
Sortimente in der stabilen
und sicheren StrongBox*

**Long lasting premium quality
in every detail:
15 years guarantee on every
component**

*Hochwertig und langlebig:
15 Jahre Garantie auf jedes Stück*





Item No



EAN-Code

057

1/4" 

R-GO XL	36-pcs / Satz 36-tlg	057 836 16	955	40 07157 61547 3
	ERGONIC Ratchet 1/4" / ERGONIC Ratsche 1/4"			
	ERGONIC Stubby 1/4" / ERGONIC Stubby 1/4"			
(13 x)	Sockets / Steckschlüsseinsätze			
	4 / 4,5 / 5 / 5,5 / 6 / 7 / 8 / 9 / 10 / 11 / 12 / 13 / 14mm			
(15 x)	Bits (C6,3 x 25mm)			
	4,5 x 0,6 / 5,5 x 1,0			
	4 / 5 / 6mm			
	PH1 / 2 / 3			
	PZ1 / 2			
	Torx® 10 / 15/ 20/ 25/ 30			
	Extension / Verlängerung (100mm) 1/4" - 1/4"			
	Extension / Verlängerung (50mm) 1/4" - 1/4"			
	U-Joint / Kardangelenk 1/4"			
	Bitholder / Bithalter E6,3 x 58mm			
	Adapter / Adapter E 6,3 - 1/4" (50mm)			
	Adapter / Adapter 1/4" SQ - 1/4" Hex			
	StrongBox 230 mm x 130 mm x 56 mm			



057



		Item No		EAN-Code
R-GO M-Tec	Box 10-pcs / Satz 10-tlg	057 810 06	1050	40 07157 615534
	ERGONIC Ratchet 1/4" / ERGONIC Ratsche 1/4"			
	ERGONIC Screwdriver with 1/4" adapter for sockets / <i>ERGONIC Schraubendreher mit 1/4" Adapter für Steckschlüsseleinsätze</i>			
(6 x)	Nutdrivers / M-Tec Steckschlüssel 5,5 / 6 / 7 / 8 / 10 / 13mm			
	Extension / Verlängerung (100mm) 1/4" - 1/4"			
	U-Joint / Kardangelenk 1/4"			
	StrongBox 230 mm x 130 mm x 56 mm			



057



		Item No		EAN-Code
R-GO 19	Box 19-pcs / Satz 19-tlg	057 819 06	955	40 07157 61555 8
	ERGONIC Ratchet 1/4" / ERGONIC Ratsche 1/4"			
	ERGONIC Screwdriver with 1/4" adapter for sockets / <i>ERGONIC Schraubendreher mit 1/4" Adapter für Steckschlüsseleinsätze</i>			
(13 x)	Sockets / Steckschlüsseleinsätze 4 / 4,5 / 5 / 5,5 / 6 / 7 / 8 / 9 / 10 / 11 / 12 / 13 / 14mm			
	Extension / Verlängerung (100mm) 1/4" - 1/4"			
	Extension / Verlängerung (50mm) 1/4" - 1/4"			
	U-Joint / Kardangelenk 1/4"			
	Adapter / Adapter E 6,3 - 1/4" (50mm)			
	StrongBox 230 mm x 130 mm x 56 mm			

057



	Item No		EAN-Code
R-GO 27 Inch/metric Box 27-pcs / Satz 27-tlg	057 827 06	1060	41 07157 62371 3
ERGONIC Ratchet 1/4" / ERGONIC Ratsche 1/4"			
ERGONIC Screwdriver with 1/4" adapter for sockets / <i>ERGONIC Schraubendreher mit 1/4" Adapter für Steckschlüsseinsätze</i>			
[21 x]	Sockets / Steckschlüsseinsätze		
	4 / 4,5 / 5 / 5,5 / 6 / 7 / 8 / 9 / 10 / 11 / 12 / 13 / 14mm		
	3/16" 7/32" 1/4" 9/32" 5/16" 3/8" 7/16" 1/2"		
	Extension / Verlängerung (100mm) 1/4" - 1/4"		
	Extension / Verlängerung (50mm) 1/4" - 1/4"		
	U-Joint / Kardangelenk 1/4"		
	Adapter / Adapter E 6,3 - 1/4" (50mm)		
	StrongBox 230 mm x 130 mm x 56 mm		

057



	Item No		EAN-Code
R-GO 36 Box 36-pcs / Satz 36-tlg	057 836 06	900	4007157 61557 2
ERGONIC Ratchet 1/4" / ERGONIC Ratsche 1/4"			
ERGONIC 438 Screwdriver with Bitholder / ERGONIC 438 Schraubendreher mit Bithalter			
[30 x]	Bits (C6,3 x 25mm)		
	3,0 x 0,5/ 4,5 x 0,6 / 5,5 x 1,0/ 6,5 x 1,2 / 2mm/ 3mm/ 4mm/ 5mm/ 6mm		
	PH0/ 1 / 2 / 3 / PZ1 / 2 / 3		
	Torx® 5 / 6 / 7 / 8 / 10 / 15 / 20 / 25 / 30 / 40		
	SQ1 / 2 / Spanner 6 / 8		
	Extension (100mm) 1/4" - 1/4" / Verlängerung		
	Extension (50mm) 1/4" - 1/4" / Verlängerung		
	Bitholder E6,3 x 58mm / Bithalter		
	Adapter 1/4" SQ - 1/4" Hex / Adapter		
	StrongBox 230 mm x 130 mm x 56 mm		

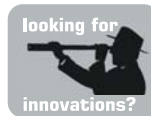

057



		Item No		EAN-Code
R-GO XL Inch	36-pcs / Satz 36-tlg	057 836 56	955	40 07157 62053 8
	ERGONIC Ratchet 1/4" / ERGONIC Ratsche 1/4"			
	ERGONIC Stubby 1/4" / ERGONIC Stubby 1/4"			
(13 x)	Sockets / Steckschlüsseleinsätze			
	1/8" 9/64" 5/32" 3/16" 7/32" 1/4" 9/32" 5/16" 11/32" 3/8" 7/16" 1/2" 9/16"			
(15 x)	Bits (C6,3 x 25mm)			
	4,5 x 0,6 / 5,5 x 1,0			
	PH1/ 2 / 3			
	Torx® 8 / 10 / 15 / 20 / 25 / 30			
	SQ 0 (1,75 mm) / 1 (2,30 mm) / 2 (2,80 mm) / 3 (3,30 mm)			
	Extension / Verlängerung (100mm) 1/4" - 1/4"			
	Extension / Verlängerung (50mm) 1/4" - 1/4"			
	U-Joint / Kardangelenk 1/4"			
	Bitholder / Bithalter E6,3 x 58mm			
	Adapter / Adapter E 6,3 - 1/4" (50mm)			
	Adapter / Adapter 1/4" SQ - 1/4" Hex			
	StrongBox 230 mm x 130 mm x 56 mm			



057



	Item No		EAN-Code
R-GO 19 Inch	Box 19-pcs / Satz 19-tlg	057 819 56	955 40 07157 62055 2
	ERGONIC Ratchet 1/4" / ERGONIC Ratsche 1/4"		
	ERGONIC Screwdriver with 1/4" adapter for sockets / <i>ERGONIC Schraubendreher mit 1/4" Adapter für Steckschlüsseinsätze</i>		
(13 x)	Sockets / Steckschlüsseinsätze 1/8" 9/64" 5/32" 3/16" 7/32" 1/4" 9/32" 5/16" 11/32" 3/8" 7/16" 1/2" 9/16"		
	Extension / Verlängerung (100mm) 1/4" - 1/4"		
	Extension / Verlängerung (50mm) 1/4" - 1/4"		
	U-Joint / Kardangelenk 1/4" 		
	Adapter / Adapter E 6,3 - 1/4" (50mm)		
	StrongBox 230 mm x 130 mm x 56 mm		

497



	Item No		EAN-Code
ERGONIC Ratchet 1/4" in Blister/	497 635 41	128	40 07157 61481 0
<i>ERGONIC Ratsche 1/4" auf Karte</i>			

096



	Item No		EAN-Code
Nutdriver M-TEC / Steckschlüssel M-TEC			
5,5mm	86	1/4" 1	096 055 20 31 40 07157 61713 2
6mm	86	1/4" 1	096 060 20 33 40 07157 61715 6
7mm	86	1/4" 1	096 070 20 41 40 07157 61717 0
8mm	86	1/4" 1	096 080 20 45 40 07157 61719 4
10mm	103	1/4" 1	096 100 20 57 40 07157 61721 7
13mm	103	1/4" 1	096 130 20 114 40 07157 61723 1



**Super strong ratcheting mechanism with fine toothing
(>65 Nm, 60 teeth, 6° ratcheting angle)**

*Super-starke Umschaltmechanik mit Feinverzahnung
(>65Nm, 60 Zähne, 6° Rückholwinkel)*

**Direct fit for bits =
extreme low operating height**

*mit Bit-Direktaufnahme -
extrem niedrige Kopfhöhe!*



**Slightly angled handle makes work
more comfortable and protects
the fingers**

*Leicht abgewinkelter Griff erleichtert
das Arbeiten und schützt die Finger*

XS

Pocket size tool sets built for tough work in tight spaces

*Werkzeugsätze im Hosentaschen-Format:
gebaut für harten Einsatz auf beengtem Raum*



**Ratchet forged in one piece
from chrom-vanadium steel**

*Ratsche einteilig aus Chrom
Vanadium Stahl geschmiedet*

**Practice oriented assortments
stored in robust, splashproof
mini StrongBox**

*Verschiedene anwendungsgerechte
Sortimente in der stabilen, spritz-
wassergeschützten mini StrongBox*

**Long lasting premium quality
in every detail:
15 years guarantee on every
component**

*Hochwertig und langlebig:
15 Jahre Garantie auf jedes Stück*



057



Item No



EAN-Code

XS 11	11-pcs / Satz 11-tlg	057 711 06	410	40 07157 61559 6
	Mini Ratchet 1/4" / Miniratsche 1/4"			
(7 x)	Sockets / Steckschlüsseleinsätze			
	5,5 / 6 / 7 / 8 / 10 / 11 / 13mm/			
	Extension / Verlängerung (100mm) 1/4" - 1/4"			
	Adapter / Adapter E 6,3 - 1/4" (50mm)			
	Adapter / Adapter C 6,3 - 1/4" (25mm)			
	StrongBox 135mm x 75mm x 37mm			

057



Item No



EAN-Code

XS 18	18-pcs / Satz 18-tlg	057 718 06	420	40 07157 61561 9
	Mini Ratchet 1/4" / Miniratsche 1/4"			
(7 x)	Sockets / Steckschlüsseleinsätze			
	5 / 5,5 / 6 / 7 / 8 / 10 / 13mm			
(7 x)	Bits (C6,3 x 25mm)			
	4,5 x 0,6 / 5,5 x 0,8/ 6,5 x 1,2			
	PH1/ 2 / 3			
	PZ2			
	Extension / Verlängerung (50mm) 1/4" - 1/4"			
	Adapter / Adapter C 6,3 - 1/4" (25mm)			
	Bitholder / Bithalter E6,3 x 58mm			
	StrongBox 135mm x 75mm x 37mm			



057



		Item No		EAN-Code
XS 33	33-pcs / Satz 33-tlg	057 733 06	425	40 07157 61545 9
	Mini Ratchet 1/4" / Miniratsche 1/4"			
(30 x)	Bits (C6,3 x 25mm)			
	3,0 x 0,5 / 5,0 x 0,8 / 6,5 x 1,2			
	2 / 2,5 / 3 / 4 / 5 / 6 / 8mm			
	PH0/ PH1 / 2x PH2 / PH3			
	PZ1/ 2x PZ2 / PZ3			
	Torx® 6/ 7/ 8/ 9			
	Torx® TR10 / 15 / 20 / 25 / 27 / 30 / 40			
	Adapter / Adapter C 6,3 - 1/4" (25mm)			
	Bitholder / Bithalter E6,3 x 58mm			
	StrongBox 135mm x 75mm x 37mm			



The best tools for optimum work results.

Bestes Werkzeug für beste Arbeit.

*André Felo
Lihare Gg*



057



Item No 057 711 56 **EAN-Code** 410 40 07157 62057 6

XS 11 Inch **11-pcs / Satz 11-tlg**
Mini Ratchet 1/4" / Miniratsche 1/4"
 (7 x) **Sockets / Steckschlüsseleinsätze**
 3/16" | 7/32" | 1/4" | 9/32" | 5/16" | 3/8" | 1/2"
Extension / Verlängerung (100mm) 1/4" - 1/4"
Adapter / Adapter E 6,3 - 1/4" (50mm)
Adapter / Adapter C 6,3 - 1/4" (25mm)
StrongBox 135mm x 75mm x 37mm

057



Item No 057 718 56 **EAN-Code** 420 40 07157 62059 0

XS 18 Inch **18-pcs / Satz 18-tlg**
Mini Ratchet 1/4" / Miniratsche 1/4"
 (7 x) **Sockets / Steckschlüsseleinsätze**
 3/16" | 7/32" | 1/4" | 9/32" | 5/16" | 3/8" | 1/2"
 (7 x) **Bits (C6,3 x 25mm)**
 4,5 x 0,6 / 5,5 x 0,8 / 6,5 x 1,2
 PH1 / 2 / 3
 SQ2
Extension / Verlängerung (50mm) 1/4" - 1/4"
Adapter / Adapter C 6,3 - 1/4" (25mm)
Bitholder / Bithalter E6,3 x 58mm
StrongBox 135mm x 75mm x 37mm

057



Item No



EAN-Code

Mini Ratchet 1/4" with Adapter C 6,3 - 1/4" in blister

057 635 01

118

40 07157 61569 5

Miniratsche 1/4" mit Adapter C 6,3 - 1/4" auf Karte



438



Item No



EAN-Code

ERGONIC Stubby Handle 1/4"



438 025 40

32

40 07157 61585 5

ERGONIC Stubby Griff 1/4"



389



Item No



EAN-Code

Belt-Pouch for XS StrongBox (in blister)

389 800 01

100

40 07157 61733 0

Gürteltasche für XS Strongbox (in Blister)

097



Item No



EAN-Code

Extension / Verlängerung



50mm

1/4"

1

097 050 10

22

40 07157 61683 8

100mm

1/4"

1

097 100 10

43

40 07157 61681 4

097



1/4" ■

				Item No		EAN-Code
U-Joint 1/4"			1	097 000 10	22	40 07157 61729 3
<i>Kardangelenk 1/4"</i>						

097



1/4" □

					Item No		EAN-Code
Adapter	25 mm	1/4"	C 6,3	1	097 019 10	25	40 07157 61685 2

096



mm				Item No		EAN-Code
4	25	1/4"	1	096 040 10	10	40 07157 61687 6
4,5	25	1/4"	1	096 045 10	10	40 07157 61689 0
5	25	1/4"	1	096 050 10	10	40 07157 61691 3
5,5	25	1/4"	1	096 055 10	10	40 07157 61693 7
6	25	1/4"	1	096 060 10	11	40 07157 61695 1
7	25	1/4"	1	096 070 10	11	40 07157 61697 5
8	25	1/4"	1	096 080 10	12	40 07157 61699 9
9	25	1/4"	1	096 090 10	12	40 07157 61701 9
10	25	1/4"	1	096 100 10	12	40 07157 61703 3
11	25	1/4"	1	096 110 10	18	40 07157 61705 7
12	25	1/4"	1	096 120 10	21	40 07157 61707 1
13	25	1/4"	1	096 130 10	23	40 07157 61709 5
14	25	1/4"	1	096 140 10	31	40 07157 61711 8

096



Inch				Item No		EAN-Code
1/8"	25	1/4"	1	096 200 10	10	40 07157 62757 5
9/64"	25	1/4"	1	096 210 10	10	40 07157 62759 9
5/32"	25	1/4"	1	096 220 10	10	40 07157 62761 2
3/16"	25	1/4"	1	096 230 10	10	40 07157 62763 6
7/32"	25	1/4"	1	096 240 10	11	40 07157 62765 0
1/4"	25	1/4"	1	096 250 10	11	40 07157 62767 4
9/32"	25	1/4"	1	096 260 10	12	40 07157 62769 8
5/16"	25	1/4"	1	096 270 10	12	40 07157 62771 1
11/32"	25	1/4"	1	096 280 10	12	40 07157 62773 5
3/8"	25	1/4"	1	096 290 10	18	40 07157 62775 9
7/16"	25	1/4"	1	096 300 10	21	40 07157 62777 3
1/2"	25	1/4"	1	096 310 10	23	40 07157 62779 7
9/16"	25	1/4"	1	096 320 10	31	40 07157 62781 0

2-component handle with pleasant soft grip material for highest torque

2-Komponenten Griff mit angenehm griffigen Weichmantel für höchste Drehmomente

Professional quality & great versatility

Kompromisslose Profi-Qualität und größte Einsatz-Vielfalt

smart

screwdriver and T-handle in one

Schraubendreher und T-Griff in Einem



ergonomically refined design

ergonomisch ausgereiftes Design

replaces 48 single tools

ersetzt 48 Einzelwerkzeuge

blades made from high-quality bit-steels, exceeding the DIN/ISO requirements by up to 100%

Klingen aus Hochleistungs-Bitstählen, Härte/Drehmoment bis zu 100% über DIN-Werten

anti-roll handle design

Griffkopf mit Abrollschutz

GS tested for safety

GS - geprüfte Sicherheit



www.tuv.com
ID: 000038668

fitting the complete 1/4" range

passend für das komplette 1/4" Normprogramm

black tip for precision fit

Black-Tip für präzise Passung

060



		Item No		EAN-Code
Felo-SMART	Box 13-pcs / Satz 13-tlg.	060 813 06	1090	40 07157 60413 2
[12 x]	Blade / Klinge 1/4" x 160 mm			
	PZ 1 - 5,0 / PZ 2 - 6,0 / PZ 3 - 7,0 / PH 1 - 4,0 / PH 2 - PH 3			
	3 mm - 4 mm / 5 mm - 6 mm /			
	Torx® 6 - Torx® 7 / Torx® 8 - Torx® 9 / Torx® 10 - Torx® 15 / Torx® 20 - Torx® 25 / Torx® 30 - Torx® 40			
	Handle / Griff 105 x 39 mm			
	StrongBox 230mm x 130mm x 56mm			

060

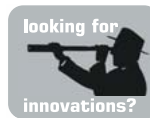

		Item No		EAN-Code
Felo-SMART II	Box 29-pcs / Satz 29-tlg	060 815 06	985	40 07157 60415 6
[16 x]	Bits C 6,3 x 25 mm			
	PZ 1 / 2 / 3 / PH 1 / 2 / 3			
	5 mm / 6 mm / 3,5 x 0,6 / 5,0 x 0,8 / 6,5 x 1,2			
	Torx®15 / 20 / 25 / 30 / 40			
	Bit Holder with Quick-Release Chuck / Bit Schnellwechselfutter			
[7 x]	Socket / Steckschlüssel			
	4 / 5 / 5,5 / 6 / 8 / 10 / 13 mm			
	Adapter / Adapter 1/4" - C 6,3 (Art.No. 097 018 10)			
	Extension / Verlängerung , 1/4" - E 6,3 (Art.No. 097 150 14)			
	Extension for Sockets / Verlängerung für Steckschlüssel 75 mm			
	Ergonic Ratchet / Ergonic Ratsche 1/4"			
	Handle / Griff 105 x 39 mm			
	StrongBox 230mm x 130mm x 56mm			



M-TEC

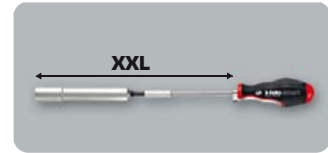
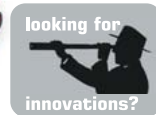

060



		Item No		EAN-Code
Felo-SMART Engineer	Box 20-pcs / Satz 20-tlg	060 820 06	1218	40 07157 60421 7
(7 x)	M-Tec 1/4"			
	5,5 mm x 116 mm / 6 mm x 116 mm / 7 mm x 116 mm / 8 mm x 116 mm /			
	10 mm x 133 mm / 13 mm x 133 mm /			
	17 x 158 mm			
	Bitholder / Bithalter 1/4" x 47 mm			
	Bitholder / Bithalter 1/4" x 155 mm			
(10 x)	Bits C 6,3 x 25 mm			
	PZ 1 / 2 / PH 1 / 2 /			
	3,5 x 0,6 / 5,0 x 0,8			
	Torx 15 / 20 / 25 / 30			
	Handle / Griff 105 x 39 mm			
	StrongBox 230mm x 130mm x 56mm			

Compact, without compromises in quality and function.

Kompakt, ohne Kompromiss bei Qualität oder Funktion.

Kla. Pfl.

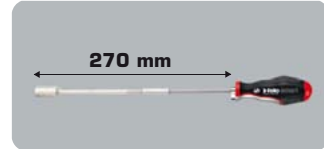

060



		Item No		EAN-Code
Felo-SMART Engineer Inch Version / Zoll Version		060 920 36	1286	40 07157 52953 4
Box 20-pcs / Satz 20-tlg				
(8 x)	Socket / Steckschlüssel E 6,3 x 155			
	7/32" 1/4" 9/32" 5/16" 3/8" 7/16" 1/2" 9/16"			
	Bitholder / Bithalter 1/4"			
(10 x)	Bits C 6,3 x 25 mm			
	PZ 1 / 2 / PH1 / 2 /			
	3,5 x 0,6 / 5,0 x 0,8			
	Torx® 15 / 20 / 25 / 30			
	Handle / Griff 105 x 39 mm			
	Metal Case / Stahlblech Box 220 mm, 110 mm, 35 mm			

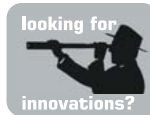

060



		Item No		EAN-Code
Felo-SMART belt pouch / Gürteltasche		060 809 04	566	40 07157 60425 5
Pouch 9-pcs / Gürteltasche 9-tlg				
(8 x)	Blade / Klinge			
	PZ 1 - 5,0 / PZ 2 - 6,0 / PZ 3 - 7,0			
	PH 1 - 4,0 / PH 2 - PH 3			
	5 mm - 6 mm /			
	Torx® 20 - Torx® 25 / Torx® 30 - Torx® 40			
	Handle / Griff 105 x 39 mm			
	Nylon Pouch / Nylon Tasche			



069



SMART-Handle / SMART-Griff

Item No	Unit	EAN-Code
069 205 00	105	40 07157 60427 9

069



Nylon Pouch / Nylon Tasche

Item No	Unit	EAN-Code
389 900 00	80	40 07157 50456 2

068



Size	Length	Hex Size	Quantity	Item No	Unit	EAN-Code
5,5 mm	155 mm	E 6,3 / 1/4"	1	068 055 04	52	40 07157 52709 7
6 mm	155 mm	E 6,3 / 1/4"	1	068 060 04	52	40 07157 52711 0
7 mm	155 mm	E 6,3 / 1/4"	1	068 070 04	57	40 07157 50302 2
8 mm	155 mm	E 6,3 / 1/4"	1	068 080 04	60	40 07157 50304 6
10 mm	155 mm	E 6,3 / 1/4"	1	068 100 04	64	40 07157 50306 0
11 mm	155 mm	E 6,3 / 1/4"	1	068 110 04	73	40 07157 52713 4
13 mm	155 mm	E 6,3 / 1/4"	1	068 130 04	76	40 07157 50308 4
17 mm	155 mm	E 6,3 / 1/4"	1	068 170 04	102	40 07157 52715 8

068



Size	Length	Hex Size	Quantity	Item No	Unit	EAN-Code
7/32"	155 mm	E 6,3 / 1/4"	1	068 555 04	51	40 07157 53195 7
1/4"	155 mm	E 6,3 / 1/4"	1	068 635 04	52	40 07157 53197 1
9/32"	155 mm	E 6,3 / 1/4"	1	068 714 04	57	40 07157 53199 5
5/16"	155 mm	E 6,3 / 1/4"	1	068 793 04	59	40 07157 53201 5
3/8"	155 mm	E 6,3 / 1/4"	1	068 952 04	64	40 07157 53203 9
7/16"	155 mm	E 6,3 / 1/4"	1	068 111 04	72	40 07157 53205 3
1/2"	155 mm	E 6,3 / 1/4"	1	068 127 04	77	40 07157 53207 7
9/16"	155 mm	E 6,3 / 1/4"	1	068 142 04	77	40 07157 53209 1



				Item No		EAN-Code
PH 1 - 4,0 x 0,8	160 mm	1/4"	1	062 104 04	42	40 07157 32116 9
PH 1 - 7,0 x 1,2	160 mm	1/4"	1	062 107 04	43	40 07157 50312 1
PH 2 - PH 3	160 mm	1/4"	1	062 023 04	44	40 07157 32118 3
PH 2 - 6,0 x 1,0	160 mm	1/4"	1	062 206 04	41	40 07157 50310 7
PZ 1 - 5,0 x 0,8	160 mm	1/4"	1	061 105 04	42	40 07157 32110 7
PZ 2 - 6,0 x 1,0	160 mm	1/4"	1	061 206 04	43	40 07157 32112 1
PZ 3 - 7,0 x 1,2	160 mm	1/4"	1	061 307 04	44	40 07157 32114 5
3 mm - 4 mm	160 mm	1/4"	1	064 034 04	44	40 07157 32106 0
5 mm - 6 mm	160 mm	1/4"	1	064 056 04	45	40 07157 32130 5
Torx® 06 - Torx® 07	160 mm	1/4"	1	066 067 04	42	40 07157 32096 4
Torx® 08 - Torx® 09	160 mm	1/4"	1	066 089 04	41	40 07157 32098 8
Torx® 10 - Torx® 15	160 mm	1/4"	1	066 115 04	41	40 07157 32100 8
Torx® 20 - Torx® 25	160 mm	1/4"	1	066 225 04	42	40 07157 32102 2
Torx® 30 - Torx® 40	160 mm	1/4"	1	066 340 04	45	40 07157 32104 6
SQ 0 - SQ 1	160 mm	1/4"	1	065 001 04	46	40 07157 50346 6
SQ 2 - SQ 3	160 mm	1/4"	1	065 023 04	48	40 07157 50348 0
Torx®TR 10 - Torx®TR 15	160 mm	1/4"	1	067 115 04	46	40 07157 32120 6
Torx®TR 20 - Torx®TR 25	160 mm	1/4"	1	067 225 04	46	40 07157 32122 0
Torx®TR 30 - Torx®TR 45	160 mm	1/4"	1	067 340 04	48	40 07157 32124 4

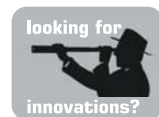

068



				Item No		EAN-Code
5,5 mm	116 mm	1/4"	1	068 055 24	50	40 07157 60541 2
6,0 mm	116 mm	1/4"	1	068 060 24	66	40 07157 60543 6
7,0 mm	116 mm	1/4"	1	068 070 24	69	40 07157 60545 0
8,0 mm	116 mm	1/4"	1	068 080 24	72	40 07157 60547 4
10,0 mm	133 mm	1/4"	1	068 100 24	87	40 07157 60549 8
13,0 mm	133 mm	1/4"	1	068 130 24	137	40 07157 60551 1
17,0 mm	158 mm	1/4"	1	068 170 24	217	40 07157 60553 5



097



				Item No		EAN-Code
Adapter	150 mm	E 6,3 / 1/4"	1	097 150 14	62	40 07157 32128 2
Bitholder / Bithalter	155 mm	1/4"	1	068 635 14	62	40 07157 53179 7

12 interchangeable IEC screwdriver blades with 2-component handle in sturdy smart box

12 IEC Wechselklingen mit 2-Komponenten-Griff in robuster smart Box

every screwdriver individually tested to 10.000 Volts, fully conforming to DIN EN 60900

Sicherheitswerkzeug nach DIN EN 60900 – alle Schraubendreher stückgeprüft mit 10.000 Volt

**AC 1000V
IEC 60900 : 2012**



secure fit of blades, quick-release button on handle against unwanted extraction

sicherer Halt der Klingen im Griff, automatische Verriegelung gegen ungewolltes Herausziehen



The first compact smart tool for electricians.
Esmart (pat.)

Das erste kompakte smart-Werkzeug für Elektriker.



precision cap and soft-grip zone on blades for low torque application

aufsteckbare Drehkappe und Weichmantelzone für Einsatz als Feinwerkzeuge



063



AC 1000V
IEC 60900 : 2012



	Item No		EAN-Code
Felo E-SMART Box 14-pce / Box 14-tlg.	063 913 06	984	40 07157 51719 7
[12 x] Blade / Klinge	2,5 x 0,4 / 3,0 x 0,5 / 3,5 x 0,6 / 4,0 x 0,8 / 5,5 x 1,0 / 6,5 x 1,2		
	PH1 / PH2		
	PZ2		
	Torx® 10 / Torx® 15 / Torx® 20		
[1 x] Handle / Griff 95 x 32 mm			
[1 x] Precision Cap / Drehkappe			
StrongBox 230mm x 130mm x 56mm			

060



AC 1000V
IEC 60900 : 2012



	Item No		EAN-Code
Felo E-SMART Industry Box 14-pce / Box 14-tlg.	063 913 16	1071	40 07157 53263 3
[10 x] Blade / Klinge	2,5 x 0,4 / 3,0 x 0,5 / 3,5 x 0,6 / 4,0 x 0,8 / 5,5 x 1,0 / 6,5 x 1,2		
	PH 1 / PH 2		
	PZ 2		
	Z 2		
[1 x] Bit, Spanner 10 x 25			
[1 x] Universal Cabinet key / Schaltschrankschlüssel			
[1 x] Handle / Griff 95 x 32 mm			
[1 x] Precision Cap / Drehkappe			
StrongBox 230mm x 130mm x 56mm			





AC 1000V
IEC 60900 : 2012



Item No



EAN-Code

063

Felo E-SMART Box in Blister Box 14-pce / Box 14-tlg.

063 913 01

1044

40 07157 53077 6

(12 x)

Blade / Klinge

2,5 x 0,4 / 3,0 x 0,5 / 3,5 x 0,6 / 4,0 x 0,8 / 5,5 x 1,0 / 6,5 x 1,2

PH 1 / PH 2

PZ 2

Torx® 10 / 15 / 20

(1 x)

Handle / Griff 95 x 32 mm

(1 x)

Precision Cap / Drehkappe

StrongBox 230mm x 130mm x 56mm



AC 1000V
IEC 60900 : 2012



Item No



EAN-Code

063

Zip-Bag 19-pcs/ Reißverschlussstasche 19-tlg.

063 919 04

1550

40 07157 60353 1

(14 x)

Blade / Klinge

2,5 x 0,4 / 3,0 x 0,5 / 3,5 x 0,6 / 4,0 x 0,8 / 5,5 x 1,0 / 6,5 x 1,2

PH 1 / PH 2

PZ 2

Torx® 10 / 15 / 20

H 2

Z 2

(1 x)

Handle / Griff 95 x 32 mm

(1 x)

Precision Cap / Drehkappe

(1 x)

Combination Pliers / Kombizange 180 mm

(1 x)

Diagonal Nippers / Seitenschneider 160 mm

(1 x)

Mains testing Screwdriver / Spannungsprüfer 3,0 mm x 70 mm

(VDE 0680/6, 150-250 Volt)

Nylon bag / Nylon Tasche 310mm, 190 mm, 70 mm



063



AC 1000V
IEC 60900 : 2012



			Item No		EAN-Code
2,5 x 0,4	75 mm	1	063 025 04	30	40 07157 51721 0
3,0 x 0,5	100 mm	1	063 030 04	34	40 07157 51723 4
3,5 x 0,6	100 mm	1	063 035 04	37	40 07157 51725 8
4,0 x 0,8	100 mm	1	063 040 04	37	40 07157 51727 2
5,5 x 1,0	100 mm	1	063 055 04	45	40 07157 51729 6
6,5 x 1,2	100 mm	1	063 065 04	53	40 07157 51731 9
PH 1	80 mm	1	063 102 04	48	40 07157 51733 3
PH 2	100 mm	1	063 203 04	57	40 07157 51735 7
PZ 1	80 mm	1	063 102 14	41	40 07157 51737 1
PZ 2	100 mm	1	063 203 14	57	40 07157 51739 5
Torx® 8	100 mm	1	063 083 04	35	40 07157 51741 8
Torx® 10	100 mm	1	063 103 04	37	40 07157 51743 2
Torx® 15	100 mm	1	063 153 04	37	40 07157 51745 6
Torx® 20	100 mm	1	063 203 24	41	40 07157 51747 0
H 1	80 mm	1	063 112 04	48	40 07157 51887 3
H 2	100 mm	1	063 223 04	57	40 07157 51889 7
Z 1	80 mm	1	063 112 14	41	40 07157 51891 0
Z 2	100 mm	1	063 223 14	57	40 07157 51893 4
SQ0 (1,75 mm)	100 mm	1	063 000 04	34	40 07157 53089 9
SQ1 (2,30 mm)	100 mm	1	063 100 04	37	40 07157 53091 2
SQ2 (2,80 mm)	100 mm	1	063 200 04	57	40 07157 53093 6
SQ3 (3,30 mm)	100 mm	1	063 300 04	57	40 07157 53095 0

063



Item No		EAN-Code
063 105 00	42	40 07157 51749 4

Handle / Griff

063



- (1 x) Spanner 10
- (3 x) 5mm, 6mm, 7mm
- (1 x) 9mm
- (1 x) 3 - 5mm
- (1 x) 1/4"

Item No		EAN-Code
063 999 01	157	40 07157 62417 8

Universal Cabinet Key (in Blister)/ Schaltschrankschlüssel (in Blister)



4 IMPACT

with unique absorption cascade for best protection and longest lifetime at the toughest loads!
 mit einzigartiger Dämpfungskaskade für besten Schutz und längste Standzeiten bei härtesten Belastungen!

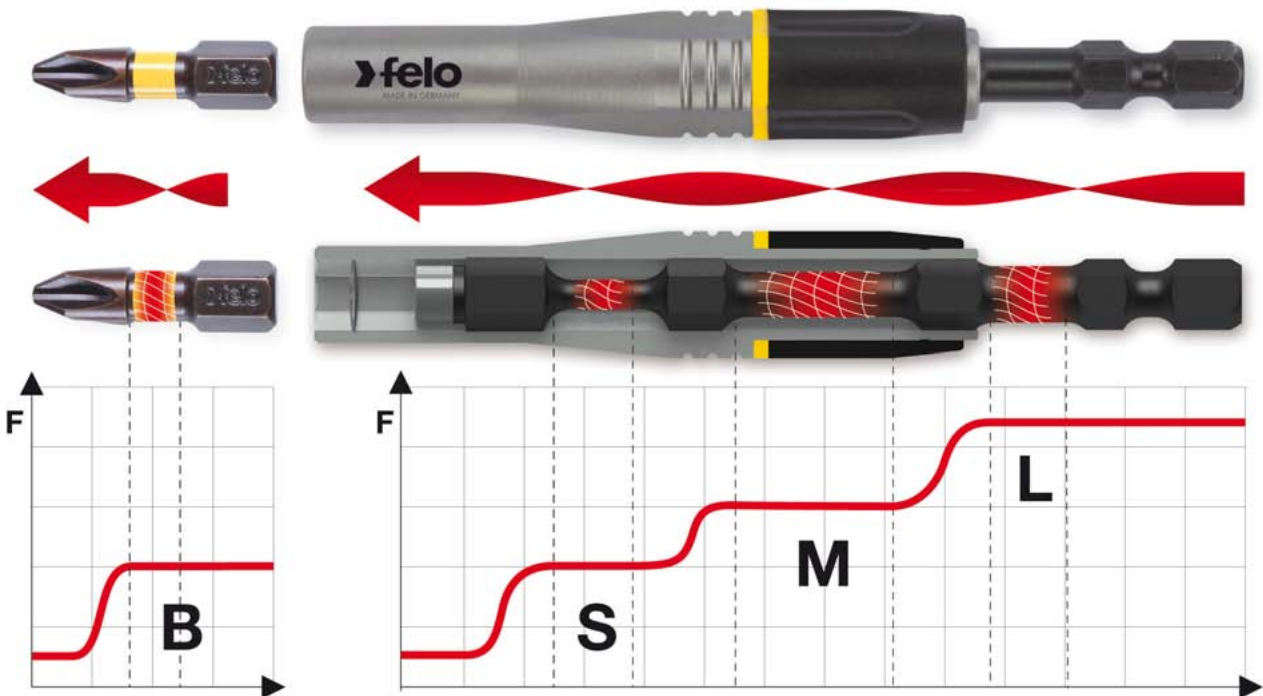

4 IMPACT

- S-M-L absorption cascade for a wide torque range (e.g. PH1 - PH3).
- Synchronized torsion-zones are sequentially triggered at increasing torque impulses and absorb torque peaks.
- Additional 4th absorption step when used with Felo IMPACT bits.
- Specially developed to be used with tangential impact drivers.
- With retaining ring.

4 IMPACT

- S-M-L Dämpfungskaskade für einen weiteren Drehmoment-Bereich (z.B. PH1 - PH3).
- Synchronisierte Torsionszonen lösen bei steigenden Momenten (Impulsen) in Folge aus und absorbieren die Drehmomente-Stöße.
- Zusätzliche 4. Dämpfungsstufe bei Einsatz mit Felo IMPACT Bits.
- Speziell entwickelt für den Einsatz in Tangential-Schlagschraubern.
- Mit Sprengring.

038
E 6,3



See also page 162 /
siehe auch Seite 162



				Item No			EAN-Code
Bitholder IMPACT 1/4" / Bithalter IMPACT 1/4"	95 mm	E 6,3	6	038 295 90	19,85	43	40 07157 63337 8

038
E 6,3



See also page 162 /
siehe auch Seite 162



			Item No		EAN-Code
Bitholder IMPACT 1/4" on Card / Bithalter IMPACT a.K.	95 mm	E 6,3	038 295 94	53	40 07157 63077 3

020

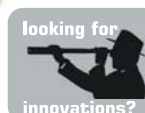

		Item No		EAN-Code
Bit-Tool IMPACT on blister / in Blister C 6,3 x 25 mm	10	020 802 46	193	40 07157 63429 0
8 Bits + IMPACT Bitholder / IMPACT Bithalter + Bitholder / Magnethalter				
[1 x] 026: Torx® 10				
[1 x] 026: Torx® 15				
[1 x] 026: Torx® 20				
[2 x] 026: Torx® 25				
[2 x] 026: Torx® 30				
[1 x] 026: Torx® 40				
[1 x] 038: IMPACT Bitholder / Bithalter				
[1 x] 038: Bitholder / Magnethalter (58 mm)				
Bit-Tool on blister / in Blister C 6,3 x 25 mm				
[1 x] 020: 0,8 x 5,5				
[1 x] 021: PZ2				
[3 x] 022: PH1 / 2 / 3				
[3 x] 026: Torx® 15 / 20 / 25				
[1 x] 038: Bitholder / Magnethalter (58 mm)				

021 C 6,3



IMPACT
PZ



Item No



EAN-Code

	Length	Material	Size	Packaging	Item No	Quantity	EAN-Code
1	25 mm	C 6,3	1/4"	5	021 010 40	3	40 07157 62939 5
2	25 mm	C 6,3	1/4"	5	021 020 40	4	40 07157 62941 8
3	25 mm	C 6,3	1/4"	5	021 030 40	5	40 07157 62943 2



022 C 6,3



IMPACT
PH



Item No



EAN-Code

	Length	Material	Size	Packaging	Item No	Quantity	EAN-Code
1	25 mm	C 6,3	1/4"	5	022 010 40	3	40 07157 62933 3
2	25 mm	C 6,3	1/4"	5	022 020 40	4	40 07157 62935 7
3	25 mm	C 6,3	1/4"	5	022 030 40	5	40 07157 62937 1



026 C 6,3



IMPACT
Torx®



Item No



EAN-Code

	Length	Material	Size	Packaging	Item No	Quantity	EAN-Code
10	25 mm	C 6,3	1/4"	5	026 100 40	3	40 07157 62945 6
15	25 mm	C 6,3	1/4"	5	026 150 40	3	40 07157 62947 0
20	25 mm	C 6,3	1/4"	5	026 200 40	4	40 07157 62949 4
25	25 mm	C 6,3	1/4"	5	026 250 40	4	40 07157 62951 7
30	25 mm	C 6,3	1/4"	5	026 300 40	5	40 07157 62953 1
40	25 mm	C 6,3	1/4"	5	026 400 40	5	40 07157 62955 5



**Felo Tools – always reliable
and made for the job.**

*Felo Werkzeuge – immer
zuverlässig und auf die
Aufgabe abgestimmt.*



031 E 6,3



IMPACT PZ					Item No		EAN-Code
1	50 mm	E 6,3	1/4"	5	031 015 40	6	40 07157 62963 0
2	50 mm	E 6,3	1/4"	5	031 025 40	7	40 07157 62965 4
3	50 mm	E 6,3	1/4"	5	031 035 40	8	40 07157 62967 8



032 E 6,3



IMPACT PH					Item No		EAN-Code
1	50 mm	E 6,3	1/4"	5	032 015 40	6	40 07157 62957 9
2	50 mm	E 6,3	1/4"	5	032 025 40	7	40 07157 62959 3
3	50 mm	E 6,3	1/4"	5	032 035 40	8	40 07157 62961 6

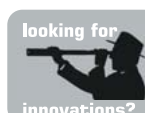

036 E 6,3



IMPACT Torx®					Item No		EAN-Code
10	50 mm	E 6,3	1/4"	5	036 105 40	8	40 07157 62969 2
15	50 mm	E 6,3	1/4"	5	036 155 40	8	40 07157 62971 5
20	50 mm	E 6,3	1/4"	5	036 205 40	8	40 07157 62973 9
25	50 mm	E 6,3	1/4"	5	036 255 40	8	40 07157 62975 3
30	50 mm	E 6,3	1/4"	5	036 305 40	9	40 07157 62977 7
40	50 mm	E 6,3	1/4"	5	036 405 40	9	40 07157 62979 1





- selected high performance steels • optimized geometry • customized production
- spezielle Hochleistungsstähle • optimierte Geometrie • angepasste Fertigungsverfahren

TORSION The high performance bit • absorbs torque peaks
 • substantially extends tool life • reduces contact pressure
 Der Hochleistungs-Bit • nimmt Drehmomentstöße auf
 • verlängert wesentlich die Standzeiten • reduziert die Anpresskräfte

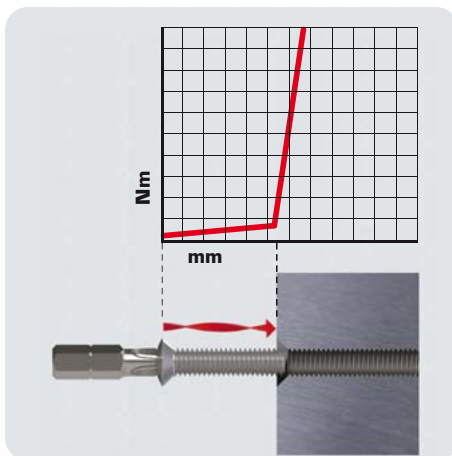

Hard screw joint

Problem:
 The sudden torque peak occurring when the screw head hits the surface of the work piece can damage screw and bit.

Solution:
 Felo TORSION bits absorb torque peaks and effectively prevent damage.

Harter Schraubfall

Problem:
 Beim Aufsetzen des Schraubenkopfs entsteht schlagartig eine Drehmomentsspitze, welche Schraube und Bit beschädigen kann.

Lösung:
 Felo Torsionsbits absorbieren Drehmoment Spitzen und verhindern wirkungsvoll Beschädigungen.

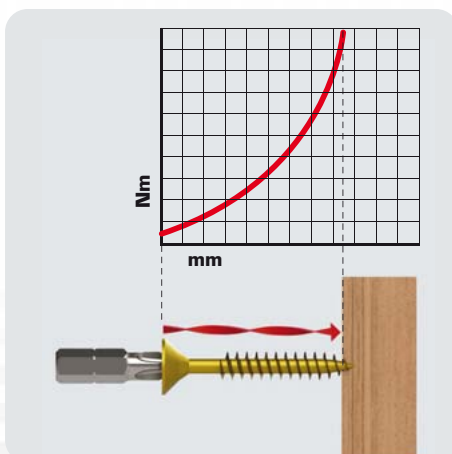

Soft screw joint

e.g. fastening screws into wood, with torque steadily increasing along the way.

Extra advantage:
 Especially wear-resistant profiles increase life span of the bits.

Weicher Schraubfall

z.B. Verschraubungen in Holz, bei denen das Drehmoment kontinuierlich ansteigt.

Zusätzlicher Vorteil:
 Besonders verschleißfeste Profile erhöhen die Lebensdauer des Bits.



021 C 6,3



TORSION PZ				Item No		EAN-Code
1	25 mm	C 6,3	1/4"	5	021 010 00	4 40 07157 62873 2
2	25 mm	C 6,3	1/4"	5	021 020 00	4 40 07157 62875 6
3	25 mm	C 6,3	1/4"	5	021 030 00	5 40 07157 62877 0

022 C 6,3

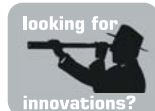

TORSION PH				Item No		EAN-Code
1	25 mm	C 6,3	1/4"	5	022 010 00	4 40 07157 62867 1
2	25 mm	C 6,3	1/4"	5	022 020 00	4 40 07157 62869 5
3	25 mm	C 6,3	1/4"	5	022 030 00	5 40 07157 62871 8

026 C 6,3

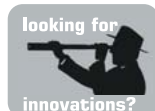

TORSION Torx®				Item No		EAN-Code
10	25 mm	C 6,3	1/4"	5	026 100 00	4 40 07157 62879 4
15	25 mm	C 6,3	1/4"	5	026 150 00	4 40 07157 62881 7
20	25 mm	C 6,3	1/4"	5	026 200 00	4 40 07157 62883 1
25	25 mm	C 6,3	1/4"	5	026 250 00	4 40 07157 62885 5
30	25 mm	C 6,3	1/4"	5	026 300 00	5 40 07157 62887 9
40	25 mm	C 6,3	1/4"	5	026 400 00	5 40 07157 62889 3

031 E 6,3

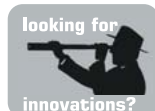

TORSION PZ				Item No		EAN-Code
1	50 mm	E 6,3	1/4"	5	031 015 00	8 40 07157 62903 6
2	50 mm	E 6,3	1/4"	5	031 025 00	8 40 07157 62905 0
3	50 mm	E 6,3	1/4"	5	031 035 00	9 40 07157 62907 4

032 E 6,3



TORSION PH				Item No		EAN-Code
1	50 mm	E 6,3	1/4"	5	032 015 00	8 40 07157 62891 6
2	50 mm	E 6,3	1/4"	5	032 025 00	8 40 07157 62893 0
3	50 mm	E 6,3	1/4"	5	032 035 00	9 40 07157 62895 4

Bits Challenger



Diamond coated

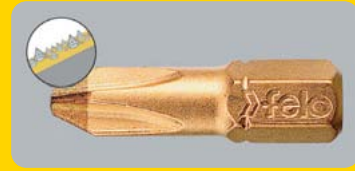

020 C 6,3



						Item No		EAN-Code
0,6 x 4,5	25 mm	C 6,3	1/4"	10	020 400 80	4	40 07157 50647 4	
1,0 x 5,5	25 mm	C 6,3	1/4"	10	020 520 80	5	40 07157 50649 8	
1,2 x 6,5	25 mm	C 6,3	1/4"	10	020 610 80	5	40 07157 50651 1	
1,2 x 8,0	25 mm	C 6,3	1/4"	10	020 800 80	7	40 07157 50653 5	

021 C 6,3

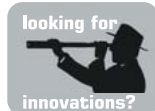

	PZ				Item No		EAN-Code
1	25 mm	C 6,3	1/4"	10	021 010 80	4	40 07157 50661 0
2	25 mm	C 6,3	1/4"	10	021 020 80	5	40 07157 50663 4
3	25 mm	C 6,3	1/4"	10	021 030 80	5	40 07157 50665 8

022 C 6,3

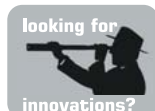

	PH				Item No		EAN-Code
1	25 mm	C 6,3	1/4"	10	022 010 80	4	40 07157 50655 9
2	25 mm	C 6,3	1/4"	10	022 020 80	5	40 07157 50657 3
3	25 mm	C 6,3	1/4"	10	022 030 80	5	40 07157 50659 7

026 C 6,3



Torx®	Length	Size	Tip	Box	Item No	Unit	EAN-Code
10	25 mm	C 6,3	1/4"	10	026 100 80	4	40 07157 50667 2
15	25 mm	C 6,3	1/4"	10	026 150 80	4	40 07157 50669 6
20	25 mm	C 6,3	1/4"	10	026 200 80	4	40 07157 50671 9
25	25 mm	C 6,3	1/4"	10	026 250 80	5	40 07157 50673 3
30	25 mm	C 6,3	1/4"	10	026 300 80	5	40 07157 50675 7
40	25 mm	C 6,3	1/4"	10	026 400 80	6	40 07157 50677 1

031 E 6,3

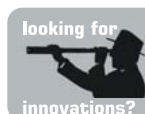

PZ	Length	Size	Tip	Box	Item No	Unit	EAN-Code
1	50 mm	E 6,3	1/4"	10	031 015 80	9	40 07157 50685 6
2	50 mm	E 6,3	1/4"	10	031 025 80	10	40 07157 50687 0
3	50 mm	E 6,3	1/4"	10	031 035 80	11	40 07157 50689 4

032 E 6,3



PH	Length	Size	Tip	Box	Item No	Unit	EAN-Code
1	50 mm	E 6,3	1/4"	10	032 015 80	9	40 07157 50679 5
2	50 mm	E 6,3	1/4"	10	032 025 80	11	40 07157 50681 8
3	50 mm	E 6,3	1/4"	10	032 035 80	11	40 07157 50683 2

Bits TiN Plus

TiN (>90 HRC)
SX 75 (>60 HRC)

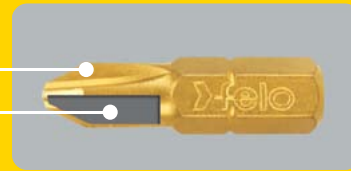

020 C 6,3 TiN



						Item No		EAN-Code
0,8 x 5,0	25 mm	C 6,3	1/4"	10	020 500 70	5	40 07157 30907 5	
1,0 x 5,5	25 mm	C 6,3	1/4"	10	020 520 70	5	40 07157 30911 2	
1,2 x 6,5	25 mm	C 6,3	1/4"	10	020 610 70	5	40 07157 30916 7	
1,2 x 8,0	25 mm	C 6,3	1/4"	10	020 800 70	6	40 07157 30921 1	

021 C 6,3 TiN



	PZ				Item No		EAN-Code
1	25 mm	C 6,3	1/4"	10	021 010 70	5	40 07157 10313 0
1 (100)	25 mm	C 6,3	1/4"	1	021 010 77	500	40 07157 53415 6
2	25 mm	C 6,3	1/4"	10	021 020 70	5	40 07157 10314 7
2 (100)	25 mm	C 6,3	1/4"	1	021 020 76	500	40 07157 53417 0
3	25 mm	C 6,3	1/4"	10	021 030 70	5	40 07157 10315 4
3 (100)	25 mm	C 6,3	1/4"	1	021 030 77	500	40 07157 53419 4

022 C 6,3 TiN



	PH				Item No		EAN-Code
1	25 mm	C 6,3	1/4"	10	022 010 70	5	40 07157 10316 1
1 (100)	25 mm	C 6,3	1/4"	1	022 010 77	500	40 07157 53421 7
2	25 mm	C 6,3	1/4"	10	022 020 70	5	40 07157 10317 8
2 (100)	25 mm	C 6,3	1/4"	1	022 020 77	500	40 07157 52339 6
3	25 mm	C 6,3	1/4"	10	022 030 70	6	40 07157 10318 5

**022
C 6,3
TiN**



extra slim



PH	→	↕	⬠	📦	Item No	📦	EAN-Code
2	25 mm	C 6,3	1/4"	10	022 002 70	5	40 07157 52471 3

**026
C 6,3
TiN**



Torx®	→	↕	⬠	📦	Item No	📦	EAN-Code
6	25 mm	C 6,3	1/4"	10	026 060 70	4	40 07157 50212 4
7	25 mm	C 6,3	1/4"	10	026 070 70	4	40 07157 50214 8
8	25 mm	C 6,3	1/4"	10	026 080 70	4	40 07157 50216 2
9	25 mm	C 6,3	1/4"	10	026 090 70	4	40 07157 50218 6
10	25 mm	C 6,3	1/4"	10	026 100 70	5	40 07157 50220 9
15	25 mm	C 6,3	1/4"	10	026 150 70	5	40 07157 50222 3
15 (100)	25 mm	C 6,3	1/4"	1	026 150 77	500	40 07157 52321 1
20	25 mm	C 6,3	1/4"	10	026 200 70	5	40 07157 50224 7
20 (100)	25 mm	C 6,3	1/4"	1	026 200 77	500	40 07157 52323 5
25	25 mm	C 6,3	1/4"	10	026 250 70	5	40 07157 50226 1
25 (100)	25 mm	C 6,3	1/4"	1	026 250 77	500	40 07157 52325 9
27	25 mm	C 6,3	1/4"	10	026 270 70	5	40 07157 50228 5
30	25 mm	C 6,3	1/4"	10	026 300 70	6	40 07157 50230 8
40	25 mm	C 6,3	1/4"	10	026 400 70	6	40 07157 50232 2
45	25 mm	C 6,3	1/4"	10	026 450 70	7	40 07157 50234 6

031 E 6,3 TiN



PZ				Item No		EAN-Code
1	50 mm	E 6,3 1/4"	10	031 015 70	9	40 07157 30801 6
2	50 mm	E 6,3 1/4"	10	031 025 70	11	40 07157 30806 1
3	50 mm	E 6,3 1/4"	10	031 035 70	12	40 07157 30813 9

032 E 6,3 TiN



PH				Item No		EAN-Code
1	50 mm	E 6,3 1/4"	10	032 015 70	9	40 07157 30818 4
2	50 mm	E 6,3 1/4"	10	032 025 70	11	40 07157 30824 5
3	50 mm	E 6,3 1/4"	10	032 035 70	12	40 07157 30831 3

036 E 6,3 TiN



Torx®				Item No		EAN-Code
10	50 mm	E 6,3 1/4"	10	036 105 70	8	4007157 32372 9
15	50 mm	E 6,3 1/4"	10	036 155 70	9	4007157 32374 3
20	50 mm	E 6,3 1/4"	10	036 205 70	9	4007157 32376 7
25	50 mm	E 6,3 1/4"	10	036 255 70	9	4007157 32378 1
30	50 mm	E 6,3 1/4"	10	036 305 70	11	4007157 32380 4
40	50 mm	E 6,3 1/4"	10	036 405 70	12	4007157 32382 8

031
E 6,3
TiN



PZ				Item No		EAN-Code
1	73 mm	E 6,3 1/4"	5	031 017 70	12	40 07157 30803 0
2	73 mm	E 6,3 1/4"	5	031 027 70	16	40 07157 30808 5

032
E 6,3
TiN



PH				Item No		EAN-Code
1	73 mm	E 6,3 1/4"	5	032 017 70	12	40 07157 30820 7
2	73 mm	E 6,3 1/4"	5	032 027 70	16	40 07157 30826 9

Bits Industrial



020 C 6,3



						Item No		EAN-Code
0,5 x 4,0	25 mm	C 6,3	1/4"	10		020 210 10	5	40 07157 24037 8
0,5 x 3,0	25 mm	C 6,3	1/4"	10		020 300 10	4	40 07157 30066 9
0,6 x 3,5	25 mm	C 6,3	1/4"	10		020 310 10	4	40 07157 30070 6
0,6 x 4,5	25 mm	C 6,3	1/4"	10		020 400 10	5	40 07157 30904 4
0,8 x 4,0	25 mm	C 6,3	1/4"	10		020 410 10	5	40 07157 30079 9
0,8 x 5,0	25 mm	C 6,3	1/4"	10		020 500 10	5	40 07157 30089 8
0,8 x 5,5	25 mm	C 6,3	1/4"	10		020 510 10	5	40 07157 30097 3
1,0 x 5,5	25 mm	C 6,3	1/4"	10		020 520 10	5	40 07157 30105 5
1,0 x 6,0	25 mm	C 6,3	1/4"	10		020 600 10	5	40 07157 30112 3
1,2 x 6,5	25 mm	C 6,3	1/4"	10		020 610 10	6	40 07157 30119 2
1,2 x 8,0	25 mm	C 6,3	1/4"	10		020 800 10	7	40 07157 30918 1

021 C 6,3



PZ						Item No		EAN-Code
0	25 mm	C 6,3	1/4"	10		021 000 10	4	40 07157 24025 5
1	25 mm	C 6,3	1/4"	10		021 010 10	5	40 07157 30159 8
1 (100)	25 mm	C 6,3	1/4"	1		021 010 17	500	40 07157 30925 9
2	25 mm	C 6,3	1/4"	10		021 020 10	5	40 07157 30169 7
2 (100)	25 mm	C 6,3	1/4"	1		021 020 17	520	40 07157 30928 0
3	25 mm	C 6,3	1/4"	10		021 030 10	6	40 07157 30180 2
3 (100)	25 mm	C 6,3	1/4"	1		021 030 17	540	40 07157 31353 9
4	32 mm	C 6,3	1/4"	10		021 042 10	12	40 07157 30190 1

022 C 6,3



PH						Item No		EAN-Code
0	25 mm	C 6,3	1/4"	10		022 000 10	4	40 07157 30937 2
1	25 mm	C 6,3	1/4"	10		022 010 10	5	40 07157 30193 2
1 (100)	25 mm	C 6,3	1/4"	1		022 010 17	470	40 07157 30940 2
2	25 mm	C 6,3	1/4"	10		022 020 10	5	40 07157 30205 2
2 (100)	25 mm	C 6,3	1/4"	1		022 020 17	510	40 07157 30943 3
3	25 mm	C 6,3	1/4"	10		022 030 10	6	40 07157 30218 2
3 (100)	25 mm	C 6,3	1/4"	1		022 030 17	560	40 07157 31351 5
4	32 mm	C 6,3	1/4"	10		022 042 10	11	40 07157 30229 8

022 C 6,3



extra slim



PH	Length	Size	Hex	Box	Item No	Unit	EAN-Code
2	25 mm	C 6,3	1/4"	10	022 002 10	4	40 07157 10238 6

021 C 6,3



PZ	Length	Size	Hex	Box	Item No	Unit	EAN-Code
1	50 mm	C 6,3	1/4"	10	021 015 10	10	40 07157 32084 1
2	50 mm	C 6,3	1/4"	10	021 025 10	11	40 07157 30178 9
3	50 mm	C 6,3	1/4"	10	021 035 10	12	40 07157 30188 8

022 C 6,3



PH	Length	Size	Hex	Box	Item No	Unit	EAN-Code
1	50 mm	C 6,3	1/4"	10	022 015 10	10	40 07157 53053 0
2	50 mm	C 6,3	1/4"	10	022 025 10	11	40 07157 30216 8
3	50 mm	C 6,3	1/4"	10	022 035 10	12	40 07157 30227 4



Modern production facilities and a well-trained work force are essential ingredients for unsurpassed product quality.

Moderne Fertigungsanlagen und hoch motivierte, gut ausgebildete Mitarbeiter sind unverzichtbar für höchste Produktqualität.

Martin Walther

024 C 6,3



mm				Item No		EAN-Code
2,0	25 mm	C 6,3 1/4"	10	024 200 10	5	40 07157 30952 5
2,5	25 mm	C 6,3 1/4"	10	024 250 10	5	40 07157 30253 3
3,0	25 mm	C 6,3 1/4"	10	024 300 10	5	40 07157 30255 7
4,0	25 mm	C 6,3 1/4"	10	024 400 10	5	40 07157 30257 1
5,0	25 mm	C 6,3 1/4"	10	024 500 10	6	40 07157 30259 5
5,5	25 mm	C 6,3 1/4"	10	024 550 10	6	40 07157 62319 5
6,0	25 mm	C 6,3 1/4"	10	024 600 10	7	40 07157 30261 8
8,0	25 mm	C 6,3 1/4"	10	024 800 10	9	40 07157 30263 2

025 C 6,3



sq				Item No		EAN-Code
0 (1,75 mm)	25 mm	C 6,3 1/4"	10	025 000 10	4	40 07157 50350 3
1 (2,30 mm)	25 mm	C 6,3 1/4"	10	025 100 10	4	40 07157 50352 7
2 (2,80 mm)	25 mm	C 6,3 1/4"	10	025 200 10	5	40 07157 50354 1
3 (3,30 mm)	25 mm	C 6,3 1/4"	10	025 300 10	5	40 07157 50356 5

026 C 6,3



Torx®				Item No		EAN-Code
5	25 mm	C 6,3 1/4"	10	026 050 10	4	40 07157 50779 2
6	25 mm	C 6,3 1/4"	10	026 060 10	4	40 07157 30953 2
7	25 mm	C 6,3 1/4"	10	026 070 10	4	40 07157 30954 9
8	25 mm	C 6,3 1/4"	10	026 080 10	4	40 07157 30955 6
9	25 mm	C 6,3 1/4"	10	026 090 10	4	40 07157 30956 3
10	25 mm	C 6,3 1/4"	10	026 100 10	5	40 07157 30957 0
10 (100)	25 mm	C 6,3 1/4"	1	026 100 17	460	40 07157 31561 8
15	25 mm	C 6,3 1/4"	10	026 150 10	5	40 07157 30959 4
15 (100)	25 mm	C 6,3 1/4"	1	026 150 17	480	40 07157 31563 2
20	25 mm	C 6,3 1/4"	10	026 200 10	5	40 07157 30961 7
20 (100)	25 mm	C 6,3 1/4"	1	026 200 17	510	40 07157 31565 6
25	25 mm	C 6,3 1/4"	10	026 250 10	5	40 07157 30963 1
25 (100)	25 mm	C 6,3 1/4"	1	026 250 17	530	40 07157 31567 0
27	25 mm	C 6,3 1/4"	10	026 270 10	5	40 07157 30965 5
30	25 mm	C 6,3 1/4"	10	026 300 10	6	40 07157 30967 9
30 (100)	25 mm	C 6,3 1/4"	1	026 300 17	620	40 07157 32569 4
40	25 mm	C 6,3 1/4"	10	026 400 10	6	40 07157 30969 3
40 (100)	25 mm	C 6,3 1/4"	1	026 400 17	620	40 07157 31571 7
45	25 mm	C 6,3 1/4"	10	026 450 10	7	40 07157 32076 6
Neu! 50	26 mm	C 6,3 1/4"	10	026 500 10	8	40 007157 32450 4
Neu! 50	32 mm	C 6,3 1/4"	10	026 501 10	10	40 007157 51399 1

027 C 6,3



Torx® TR					Item No		EAN-Code
7	25 mm	C 6,3	1/4"	10	027 070 10	4	40 07157 50771 6
8	25 mm	C 6,3	1/4"	10	027 080 10	4	40 07157 50773 0
9	25 mm	C 6,3	1/4"	10	027 090 10	4	40 07157 50775 4
10	25 mm	C 6,3	1/4"	10	027 100 10	5	40 07157 30971 6
15	25 mm	C 6,3	1/4"	10	027 150 10	5	40 07157 30972 3
20	25 mm	C 6,3	1/4"	10	027 200 10	5	40 07157 30973 0
25	25 mm	C 6,3	1/4"	10	027 250 10	5	40 07157 30974 7
27	25 mm	C 6,3	1/4"	10	027 270 10	5	40 07157 30975 4
30	25 mm	C 6,3	1/4"	10	027 300 10	6	40 07157 30976 1
40	25 mm	C 6,3	1/4"	10	027 400 10	6	40 07157 30977 8

023 C 6,3



Torx Plus®					Item No		EAN-Code
IP 6	25 mm	C 6,3	1/4"	10	023 060 10	4	40 07157 51341 0
IP 7	25 mm	C 6,3	1/4"	10	023 070 10	4	40 07157 51343 4
IP 8	25 mm	C 6,3	1/4"	10	023 080 10	4	40 07157 51345 8
IP 9	25 mm	C 6,3	1/4"	10	023 090 10	4	40 07157 51347 2
IP 10	25 mm	C 6,3	1/4"	10	023 100 10	5	40 07157 51349 6
IP 15	25 mm	C 6,3	1/4"	10	023 150 10	5	40 07157 51351 9
IP 20	25 mm	C 6,3	1/4"	10	023 200 10	5	40 07157 51353 3
IP 25	25 mm	C 6,3	1/4"	10	023 250 10	5	40 07157 51355 7
IP 27	25 mm	C 6,3	1/4"	10	023 270 10	6	40 07157 51357 1
IP 30	25 mm	C 6,3	1/4"	10	023 300 10	6	40 07157 51359 5
IP 40	25 mm	C 6,3	1/4"	10	023 400 10	6	40 07157 51361 8

028 C 6,3



Clutch					Item No		EAN-Code
5/32"	25 mm	C 6,3	1/4"	10	028 930 10	5	40 07157 52271 9
1/4"	25 mm	C 6,3	1/4"	10	028 940 10	6	40 07157 52273 3

028 C 6,3



XZN				Item No		EAN-Code
M 4	25 mm	C 6,3 1/4"	10	028 040 10	5	40 07157 50360 2
M 5	25 mm	C 6,3 1/4"	10	028 050 10	5	40 07157 50362 6
M 6	25 mm	C 6,3 1/4"	10	028 060 10	6	40 07157 50364 0
M 8	25 mm	C 6,3 1/4"	10	028 080 10	6	40 07157 50366 4
M10	25 mm	C 6,3 1/4"	10	028 100 10	8	40 07157 50368 8

029 C 6,3



TS				Item No		EAN-Code
0	25 mm	C 6,3 1/4"	10	029 000 10	5	40 07157 50370 1
1	25 mm	C 6,3 1/4"	10	029 010 10	6	40 07157 50372 5
2	25 mm	C 6,3 1/4"	10	029 020 10	5	40 07157 50374 9
3	25 mm	C 6,3 1/4"	10	029 030 10	5	40 07157 50376 3
4	25 mm	C 6,3 1/4"	10	029 040 10	5	40 07157 50378 7
5	25 mm	C 6,3 1/4"	10	029 050 10	5	40 07157 50380 0
6	25 mm	C 6,3 1/4"	10	029 060 10	5	40 07157 50382 4
8	25 mm	C 6,3 1/4"	10	029 080 10	6	40 07157 50536 1
10	25 mm	C 6,3 1/4"	10	029 100 10	6	40 07157 50819 5

029 C 6,3



Tri-Wing				Item No		EAN-Code
1	25 mm	C 6,3 1/4"	10	029 510 10	5	40 07157 52255 9
2	25 mm	C 6,3 1/4"	10	029 520 10	5	40 07157 52257 3
3	25 mm	C 6,3 1/4"	10	029 530 10	5	40 07157 52259 7
4	25 mm	C 6,3 1/4"	10	029 540 10	5	40 07157 52261 0
5	25 mm	C 6,3 1/4"	10	029 550 10	5	40 07157 52263 4

020 C 6,3



Spanner				Item No		EAN-Code
6	25 mm	C 6,3 1/4"	10	020 906 10	5	40 07157 52265 8
8	25 mm	C 6,3 1/4"	10	020 908 10	5	40 07157 52267 2
10	25 mm	C 6,3 1/4"	10	020 910 10	5	40 07157 52269 6

030 E 6,3



					Item No		EAN-Code
0,5 x 3,0	50 mm	E 6,3	1/4"	10	030 305 10	8	40 07157 30772 9
0,6 x 3,5	50 mm	E 6,3	1/4"	10	030 315 10	8	40 07157 30275 5
0,8 x 4,0	50 mm	E 6,3	1/4"	10	030 415 10	9	40 07157 30277 9
0,6 x 4,5	50 mm	E 6,3	1/4"	10	030 455 10	9	40 07157 30779 8
0,8 x 5,0	50 mm	E 6,3	1/4"	10	030 505 10	9	40 07157 30280 9
0,8 x 5,5	50 mm	E 6,3	1/4"	10	030 515 10	10	40 07157 30283 0
1,0 x 5,5	50 mm	E 6,3	1/4"	10	030 525 10	10	40 07157 30285 4
1,0 x 6,0	50 mm	E 6,3	1/4"	10	030 605 10	11	40 07157 30287 8
1,2 x 6,5	50 mm	E 6,3	1/4"	10	030 615 10	12	40 07157 30290 8
1,2 x 8,0	50 mm	E 6,3	1/4"	10	030 805 10	14	40 07157 30292 2
1,6 x 8,0	50 mm	E 6,3	1/4"	10	030 815 10	14	40 07157 30294 6
1,6 x 10,0	50 mm	E 6,3	1/4"	10	030 105 10	17	40 07157 30272 4

031 E 6,3



PZ					Item No		EAN-Code
1	50 mm	E 6,3	1/4"	10	031 015 10	9	40 07157 30309 7
2	50 mm	E 6,3	1/4"	10	031 025 10	11	40 07157 30312 7
3	50 mm	E 6,3	1/4"	10	031 035 10	11	40 07157 30315 8

032 E 6,3



PH					Item No		EAN-Code
0	50 mm	E 6,3	1/4"	10	032 005 10	8	40 07157 51015 0
1	50 mm	E 6,3	1/4"	10	032 015 10	9	40 07157 30317 2
2	50 mm	E 6,3	1/4"	10	032 025 10	11	40 07157 30320 2
2 (100)	50 mm	E 6,3	1/4"	1	032 025 17	1100	40 07157 31956 2
3	50 mm	E 6,3	1/4"	10	032 035 10	12	40 07157 30323 3

033 E 6,3



Torx Plus®					Item No		EAN-Code
IP 10	50 mm	E 6,3	1/4"	10	033 105 10	8	40 07157 51363 2
IP 15	50 mm	E 6,3	1/4"	10	033 155 10	9	40 07157 51365 6
IP 20	50 mm	E 6,3	1/4"	10	033 205 10	9	40 07157 51367 0
IP 25	50 mm	E 6,3	1/4"	10	033 255 10	10	40 07157 51369 4
IP 30	50 mm	E 6,3	1/4"	10	033 305 10	11	40 07157 51371 7

034 E 6,3



mm				Item No		EAN-Code
2,5	50 mm	E 6,3 1/4"	10	034 255 10	11	40 07157 30325 7
3,0	50 mm	E 6,3 1/4"	10	034 305 10	11	40 07157 30327 1
4,0	50 mm	E 6,3 1/4"	10	034 405 10	12	40 07157 30329 5
5,0	50 mm	E 6,3 1/4"	10	034 505 10	12	40 07157 30331 8
6,0	50 mm	E 6,3 1/4"	10	034 605 10	13	40 07157 30333 2
8,0	50 mm	E 6,3 1/4"	10	034 805 10	17	40 07157 31878 7

025 E 6,3



SQ				Item No		EAN-Code
1 (2,30 mm)	50 mm	E 6,3 1/4"	10	035 105 10	11	40 07157 63601 0
2 (2,80 mm)	50 mm	E 6,3 1/4"	10	035 205 10	11	40 07157 63603 4
3 (3,30 mm)	50 mm	E 6,3 1/4"	10	035 305 10	12	40 07157 63605 8

036 E 6,3



Torx®				Item No		EAN-Code
5	50 mm	E 6,3 1/4"	10	036 055 10	7	40 07157 50973 4
6	50 mm	E 6,3 1/4"	10	036 065 10	7	40 07157 51375 5
7	50 mm	E 6,3 1/4"	10	036 075 10	7	40 07157 51377 9
8	50 mm	E 6,3 1/4"	10	036 085 10	8	40 07157 30834 4
9	50 mm	E 6,3 1/4"	10	036 095 10	8	40 07157 30835 1
10	50 mm	E 6,3 1/4"	10	036 105 10	9	40 07157 30836 8
15	50 mm	E 6,3 1/4"	10	036 155 10	8	40 07157 24026 2
20	50 mm	E 6,3 1/4"	10	036 205 10	9	40 07157 30839 9
25	50 mm	E 6,3 1/4"	10	036 255 10	9	40 07157 30841 2
27	50 mm	E 6,3 1/4"	10	036 275 10	9	40 07157 30843 6
30	50 mm	E 6,3 1/4"	10	036 305 10	11	40 07157 30845 0
40	50 mm	E 6,3 1/4"	10	036 405 10	12	40 07157 30847 4

030 E 6,3



					Item No		EAN-Code
0,5 x 3,0	73 mm	E 6,3	1/4"	5	030 307 10	9	40 07157 30274 8
0,6 x 3,5	73 mm	E 6,3	1/4"	5	030 317 10	11	40 07157 30773 6
0,8 x 4,0	73 mm	E 6,3	1/4"	5	030 417 10	11	40 07157 30279 3
0,8 x 5,0	73 mm	E 6,3	1/4"	5	030 507 10	11	40 07157 30282 3
1,0 x 5,5	73 mm	E 6,3	1/4"	5	030 527 10	14	40 07157 30787 3
1,2 x 6,5	73 mm	E 6,3	1/4"	5	030 617 10	17	40 07157 30794 1

031 E 6,3



PZ					Item No		EAN-Code
1	73 mm	E 6,3	1/4"	5	031 017 10	12	40 07157 30311 0
2	73 mm	E 6,3	1/4"	5	031 027 10	16	40 07157 30314 1
3	73 mm	E 6,3	1/4"	5	031 037 10	18	40 07157 30815 3

032 E 6,3



PH					Item No		EAN-Code
1	73 mm	E 6,3	1/4"	5	032 017 10	12	40 07157 30319 6
2	73 mm	E 6,3	1/4"	5	032 027 10	16	40 07157 30322 6
3	73 mm	E 6,3	1/4"	5	032 037 10	18	40 07157 30833 7

035 E 6,3



SQ					Item No		EAN-Code
0 (1,75 mm)	73 mm	E 6,3	1/4"	5	035 007 10	17	40 07157 31520 5
1 (2,30 mm)	73 mm	E 6,3	1/4"	5	035 017 10	17	40 07157 31522 9
2 (2,80 mm)	73 mm	E 6,3	1/4"	5	035 027 10	18	40 07157 31524 3
3 (3,30 mm)	73 mm	E 6,3	1/4"	5	035 037 10	18	40 07157 31526 7

036 E 6,3



Torx®					Item No		EAN-Code
10	73 mm	E 6,3	1/4"	3	036 107 10	10	40 07157 30837 5
15	73 mm	E 6,3	1/4"	3	036 157 10	11	40 07157 30838 2
20	73 mm	E 6,3	1/4"	3	036 207 10	12	40 07157 30840 5
25	73 mm	E 6,3	1/4"	3	036 257 10	13	40 07157 30842 9
27	73 mm	E 6,3	1/4"	3	036 277 10	14	40 07157 30844 3
30	73 mm	E 6,3	1/4"	3	036 307 10	17	40 07157 30846 7
40	73 mm	E 6,3	1/4"	3	036 407 10	19	40 07157 30848 1

031 E 6,3



For terminal block screws



PlusMinus					Item No		EAN-Code
Z 1	73 mm	E 6,3	1/4"	5	031 101 10	12	40 07157 51883 5
Z 2	73 mm	E 6,3	1/4"	5	031 202 10	16	40 07157 51885 9

032 E 6,3



For terminal block screws



PlusMinus					Item No		EAN-Code
H 1	73 mm	E 6,3	1/4"	5	032 101 10	12	40 07157 51879 8
H 2	73 mm	E 6,3	1/4"	5	032 202 10	16	40 07157 51881 1

036 E 6,3



Torx®					Item No		EAN-Code
20	90 mm	E 6,3	1/4"	3	036 209 10	12	40 07157 51255 0
25	90 mm	E 6,3	1/4"	3	036 259 10	12	40 07157 51253 6
30	90 mm	E 6,3	1/4"	2	036 309 10	13	40 07157 51407 3

030 E 6,3



					Item No		EAN-Code
0,8 x 4,0	100 mm	E 6,3	1/4"	3	030 418 10	14	40 07157 30778 1
1,0 x 5,5	100 mm	E 6,3	1/4"	3	030 528 10	19	40 07157 30788 0
1,2 x 6,5	100 mm	E 6,3	1/4"	3	030 618 10	24	40 07157 30795 8
1,2 x 8,0	100 mm	E 6,3	1/4"	3	030 818 10	33	40 07157 30800 9

031 E 6,3



PZ					Item No		EAN-Code
1	100 mm	E 6,3	1/4"	3	031 018 10	15	40 07157 30805 4
2	100 mm	E 6,3	1/4"	3	031 028 10	22	40 07157 30810 8
3	100 mm	E 6,3	1/4"	3	031 038 10	25	40 07157 30816 0

032 E 6,3



PH					Item No		EAN-Code
1	100 mm	E 6,3	1/4"	3	032 018 10	15	40 07157 30822 1
2	100 mm	E 6,3	1/4"	3	032 028 10	22	40 07157 30828 3

031 E 6,3



PZ				Item No		EAN-Code
1	150 mm	E 6,3 1/4"	3	031 019 10	22	40 07157 30752 1
2	150 mm	E 6,3 1/4"	3	031 029 10	33	40 07157 30812 2
3	150 mm	E 6,3 1/4"	3	031 039 10	39	40 07157 30817 7

032 E 6,3



PH				Item No		EAN-Code
1	150 mm	E 6,3 1/4"	3	032 019 10	22	40 07157 30823 8
2	150 mm	E 6,3 1/4"	3	032 029 10	33	40 07157 30830 6

036 E 6,3





Neu!

Torx®				Item No		EAN-Code
10	150 mm	E 6,3 1/4"	3	036 100 10	22	40 07157 63839 7
15	150 mm	E 6,3 1/4"	3	036 150 10	22	40 07157 63565 5
20	150 mm	E 6,3 1/4"	3	036 200 10	33	40 07157 63567 9
25	150 mm	E 6,3 1/4"	3	036 250 10	39	40 07157 63569 3
30	150 mm	E 6,3 1/4"	3	036 300 10	42	40 07157 63571 6



Challenger



					 Item No		EAN-Code
1 x	PZ 1	25 mm	C 6,3	10	021 010 86	9	40 07157 52185 9
2 x	PZ 1	25 mm	C 6,3	10	021 012 86	13	40 07157 51033 4
2 x	PZ 2	25 mm	C 6,3	10	021 022 86	15	40 07157 51035 8
1 x	PZ 3	25 mm	C 6,3	10	021 030 86	10	40 07157 52187 3
2 x	PZ 3	25 mm	C 6,3	10	021 032 86	15	40 07157 51037 2
3 x 1	PZ 1 / PZ 2 / PZ 3	25 mm	C 6,3	10	021 932 86	19	40 07157 52179 8



1 x	PH 1	25 mm	C 6,3	10	022 010 86	9	40 07157 52181 1
2 x	PH 2	25 mm	C 6,3	10	022 022 86	13	40 07157 51039 6
1 x	PH 3	25 mm	C 6,3	10	022 030 86	10	40 07157 52183 5
3 x 1	PH 1 / PH 2 / PH 3	25 mm	C 6,3	10	022 931 86	19	40 07157 52177 4



1 x	Torx® 10	25 mm	C 6,3	10	026 100 86	9	40 07157 52189 7
1 x	Torx® 15	25 mm	C 6,3	10	026 150 86	9	40 07157 52191 0
1 x	Torx® 20	25 mm	C 6,3	10	026 202 86	9	40 07157 52193 4
1 x	Torx® 25	25 mm	C 6,3	10	026 252 86	10	40 07157 52195 8
1 x	Torx® 30	25 mm	C 6,3	10	026 300 86	10	40 07157 52197 2
1 x	Torx® 40	25 mm	C 6,3	10	026 400 86	11	40 07157 52199 6
3 x 1	Torx® 15 / Torx® 20 / Torx® 25	25 mm	C 6,3	10	026 933 86	18	40 07157 52175 0





see Page 204/
siehe Seite 204



TiN Plus



						Item No		EAN-Code
2 x	5,0 x 0,8	25 mm	C 6,3	10		020 500 67	15	40 07157 32134 3
2 x	5,5 x 1,0	25 mm	C 6,3	10		020 520 67	15	40 07157 31892 3
2 x	6,5 x 1,2	25 mm	C 6,3	10		020 610 67	15	40 07157 31894 7
2 x	8,0 x 1,2	25 mm	C 6,3	10		020 800 67	16	40 07157 31896 1



2 x	PZ 1	25 mm	C 6,3	10		021 010 67	15	40 07157 31898 5
2 x	PZ 2	25 mm	C 6,3	10		021 020 67	15	40 07157 31304 1
5 x	PZ 2	25 mm	C 6,3	10		021 020 57	30	40 07157 31508 3
2 x	PZ 3	25 mm	C 6,3	10		021 030 67	15	40 07157 31303 4
3 x 1	PZ 1 / PZ 2 / PZ 3	25 mm	C 6,3	10		021 932 67	20	40 07157 52171 2
2 x	PZ 1	50 mm	E 6,3	10		031 015 67	28	40 07157 31910 4
2 x	PZ 2	50 mm	E 6,3	10		031 025 67	32	40 07157 31912 8
2 x	PZ 3	50 mm	E 6,3	10		031 035 67	34	40 07157 31914 2



2 x	PH 1	25 mm	C 6,3	10		022 010 67	15	40 07157 31900 5
2 x	PH 2	25 mm	C 6,3	10		022 020 67	15	40 07157 31302 7
5 x	PH 2	25 mm	C 6,3	10		022 020 57	30	40 07157 31494 9
2 x	PH 3	25 mm	C 6,3	10		022 030 67	15	40 07157 32082 7
3 x 1	PH 1 / PH 2 / PH 3	25 mm	C 6,3	10		022 931 67	20	40 07157 32142 8
2 x	PH 1	50 mm	E 6,3	10		032 015 67	28	40 07157 31916 6
2 x	PH 2	50 mm	E 6,3	10		032 025 67	32	40 07157 31918 0
2 x	PH 3	50 mm	E 6,3	10		032 035 67	34	40 07157 31920 3





2 x	Torx® 10	25 mm	C 6,3	10		026 100 67	15	40 07157 52159 0
2 x	Torx® 15	25 mm	C 6,3	10		026 150 67	15	40 07157 52161 3
2 x	Torx® 20	25 mm	C 6,3	10		026 200 67	15	40 07157 52163 7
2 x	Torx® 25	25 mm	C 6,3	10		026 250 67	15	40 07157 52165 1
2 x	Torx® 30	25 mm	C 6,3	10		026 300 67	17	40 07157 52167 5
2 x	Torx® 40	25 mm	C 6,3	10		026 400 67	17	40 07157 52169 9
3 x 1	Torx® 15 / Torx® 20 / Torx® 25	25 mm	C 6,3	10		026 933 67	20	40 07157 52173 6



Industrial





					Item No		EAN-Code
2 x	3,5 x 0,6	25 mm	C 6,3	10	020 310 36	13	40 07157 10263 8
2 x	4,0 x 0,8	25 mm	C 6,3	10	020 410 36	15	40 07157 10264 5
2 x	5,0 x 0,8	25 mm	C 6,3	10	020 500 36	15	40 07157 31890 9
2 x	5,5 x 0,8	25 mm	C 6,3	10	020 510 36	15	40 07157 10311 6
2 x	5,5 x 1,0	25 mm	C 6,3	10	020 520 36	15	40 07157 10265 2
2 x	6,5 x 1,2	25 mm	C 6,3	10	020 610 36	17	40 07157 10266 9
2 x	8,0 x 1,2	25 mm	C 6,3	10	020 800 36	19	40 07157 10267 6



2 x	PZ 1	25 mm	C 6,3	10	021 010 36	15	40 07157 10275 1
5 x	PZ 1	25 mm	C 6,3	10	021 010 56	30	40 07157 31670 7
2 x	PZ 2	25 mm	C 6,3	10	021 020 36	15	40 07157 10276 8
5 x	PZ 2	25 mm	C 6,3	10	021 020 56	30	40 07157 10285 0
2 x	PZ 3	25 mm	C 6,3	10	021 030 36	17	40 07157 10277 5
5 x	PZ 3	25 mm	C 6,3	10	021 030 56	35	40 07157 31668 4
3 x 1	PZ 1 / PZ 2 / PZ 3	25 mm	C 6,3	10	021 932 16	21	40 07157 10281 2
2 x	PZ 1	50 mm	C 6,3	10	021 015 36	30	40 07157 53017 2
5 x	PZ 1	50 mm	C 6,3	10	021 015 56	60	40 07157 53029 5
2 x	PZ 2	50 mm	C 6,3	10	021 025 36	32	40 07157 53019 6
5 x	PZ 2	50 mm	C 6,3	10	021 025 56	65	40 07157 53031 8
2 x	PZ 3	50 mm	C 6,3	10	021 035 36	34	40 07157 53021 9
5 x	PZ 3	50 mm	C 6,3	10	021 035 56	40	40 07157 53033 2
2 x	PZ 1	50 mm	E 6,3	10	031 015 36	28	40 07157 51637 4
2 x	PZ 2	50 mm	E 6,3	10	031 025 36	32	40 07157 10287 4
2 x	PZ 2	73 mm	E 6,3	10	031 027 36	42	40 07157 10292 8
3 x 1	PZ 1 / PZ 2 / PZ 3	50 mm	E 6,3	10	031 932 16	41	40 07157 31306 5



					Item No		EAN-Code
2 x	PH 1	25 mm	C 6,3	10	022 010 36	15	40 07157 10270 6
5 x	PH 1	25 mm	C 6,3	10	022 010 56	30	40 07157 31666 0
2 x	PH 2	25 mm	C 6,3	10	022 020 36	15	40 07157 10271 3
5 x	PH 2	25 mm	C 6,3	10	022 020 56	30	40 07157 10284 3
2 x	PH 3	25 mm	C 6,3	10	022 030 36	17	40 07157 10272 0
5 x	PH 3	25 mm	C 6,3	10	022 030 56	35	40 071575 2833 9
3 x 1	PH 1 / PH 2 / PH 3	25 mm	C 6,3	10	022 931 16	21	40 07157 10280 5
2 x	PH 1	50 mm	C 6,3	10	022 015 36	30	40 07157 53023 3
5 x	PH 1	50 mm	C 6,3	10	022 015 56	60	40 07157 53035 6
2 x	PH 2	50 mm	C 6,3	10	022 025 36	32	40 07157 53025 7
5 x	PH 2	50 mm	C 6,3	10	022 025 56	65	40 07157 53037 0
2 x	PH 3	50 mm	C 6,3	10	022 035 36	34	40 07157 53027 1
5 x	PH 3	50 mm	C 6,3	10	022 035 56	70	40 07157 53039 4
2 x	PH 1	50 mm	E 6,3	10	032 015 36	30	40 07157 51639 8
2 x	PH 1	73 mm	E 6,3	10	032 017 36	34	40 07157 50520 0
2 x	PH 2	50 mm	E 6,3	10	032 025 36	32	40 07157 10286 7
2 x	PH 2	73 mm	E 6,3	10	032 027 36	42	40 07157 10304 8
3 x 1	PH 1 / PH 2 / PH 3	50 mm	E 6,3	10	032 931 16	42	40 07157 31305 8



2 x	2 mm	25 mm	C 6,3	10	024 200 36	15	40 07157 31880 0
2 x	2,5 mm	25 mm	C 6,3	10	024 250 36	15	40 07157 31882 4
2 x	3 mm	25 mm	C 6,3	10	024 300 36	15	40 07157 31884 8
2 x	4 mm	25 mm	C 6,3	10	024 400 36	15	40 07157 31886 2
5 x	4 mm	25 mm	C 6,3	10	024 400 56	30	40 07157 52867 4
2 x	5 mm	25 mm	C 6,3	10	024 500 36	17	40 07157 10291 1
2 x	6 mm	25 mm	C 6,3	10	024 600 36	19	40 07157 10290 4
2 x	8 mm	25 mm	C 6,3	10	024 800 36	23	40 07157 31888 6



2 x	Torx® 5	25 mm	C 6,3	10	026 050 36	13	40 07157 52865 0
2 x	Torx® 6	25 mm	C 6,3	10	026 060 36	13	40 07157 10303 1
2 x	Torx® 7	25 mm	C 6,3	10	026 070 36	13	40 07157 10302 4
2 x	Torx® 8	25 mm	C 6,3	10	026 080 36	13	40 07157 10301 7
2 x	Torx® 9	25 mm	C 6,3	10	026 090 36	13	40 07157 10300 0
2 x	Torx® 10	25 mm	C 6,3	10	026 100 36	15	40 07157 10299 7
2 x	Torx® 15	25 mm	C 6,3	10	026 150 36	15	40 07157 10298 0
2 x	Torx® 20	25 mm	C 6,3	10	026 200 36	15	40 07157 10297 3
2 x	Torx® 25	25 mm	C 6,3	10	026 250 36	15	40 07157 10296 6
2 x	Torx® 27	25 mm	C 6,3	10	026 270 36	15	40 07157 10295 9
2 x	Torx® 30	25 mm	C 6,3	10	026 300 36	17	40 07157 10294 2
2 x	Torx® 40	25 mm	C 6,3	10	026 400 36	17	40 07157 22194 0
3 x 1	Torx® 10 / Torx® 15 / Torx® 20	25 mm	C 6,3	10	026 931 16	20	40 07157 32222 7
3 x 1	Torx® 15 / Torx® 20 / Torx® 25	25 mm	C 6,3	10	026 933 16	20	40 07157 52157 6
3 x 1	Torx® 10 / Torx® 15 / Torx® 20	50 mm	E 6,3	10	036 931 16	20	40 07157 52243 6
3 x 1	Torx 20 / Torx 25 / Torx 30	50 mm	E 6,3	10	036 932 16	21	40 07157 52241 2







1x	Magnethalter 1/4"	58 mm	E 6,3	10	038 103 96	32	40 07157 10288 1
1x	Socket-Bit 7mm	66 mm	E 6,3	10	039 070 16	36	40 07157 52879 7
1x	Socket-Bit 8mm	66 mm	E 6,3	10	039 080 16	41	40 07157 52881 0
1x	Socket-Bit 10mm	66 mm	E 6,3	10	039 100 16	46	40 07157 52883 4
1x	Socket-Bit 13mm	66 mm	E 6,3	10	039 130 16	64	40 07157 52885 8

See also page 173

Siehe auch Seite 173



Torsion

							Item No		EAN-Code
	2 x	Torsion PZ 1	25 mm	C 6,3	10		021 012 01	13	40 07157 62915 9
	2 x	Torsion PZ 2	25 mm	C 6,3	10		021 022 01	13	40 07157 62917 3
	2 x	Torsion PZ 3	25 mm	C 6,3	10		021 032 01	15	40 07157 62919 7
	1 x	Torsion PZ 1	50 mm	E 6,3	10		031 015 01	18	40 07157 62987 6
	1 x	Torsion PZ 2	50 mm	E 6,3	10		031 025 01	18	40 07157 62989 0
	1 x	Torsion PZ 3	50 mm	E 6,3	10		031 035 01	18	40 07157 62991 3
	2 x	Torsion PH 1	25 mm	C 6,3	10		022 012 01	13	40 07157 62909 8
	2 x	Torsion PH 2	25 mm	C 6,3	10		022 022 01	13	40 07157 62911 1
	2 x	Torsion PH 3	25 mm	C 6,3	10		022 032 01	15	40 07157 62913 5
	1 x	Torsion PH 1	50 mm	E 6,3	10		032 015 01	18	40 07157 62981 4
	1 x	Torsion PH 2	50 mm	E 6,3	10		032 025 01	18	40 07157 62983 8
	1 x	Torsion PH 3	50 mm	E 6,3	10		032 035 01	18	40 07157 62985 2
	2 x	Torsion Torx® 10	25 mm	C 6,3	10		026 102 01	13	40 07157 62921 0
	2 x	Torsion Torx® 15	25 mm	C 6,3	10		026 152 01	13	40 07157 62923 4
	2 x	Torsion Torx® 20	25 mm	C 6,3	10		026 202 01	13	40 07157 62925 8
	2 x	Torsion Torx® 25	25 mm	C 6,3	10		026 252 01	13	40 07157 62927 2
	2 x	Torsion Torx® 30	25 mm	C 6,3	10		026 302 01	15	40 07157 62929 6
	2 x	Torsion Torx® 40	25 mm	C 6,3	10		026 402 01	15	40 07157 62931 9



Impact



Item No



EAN-Code



2 x	Impact PZ 1	25 mm	C 6,3	10	021 012 41	13	40 07157 63001 8
2 x	Impact PZ 2	25 mm	C 6,3	10	021 022 41	13	40 07157 63003 2
2 x	Impact PZ 3	25 mm	C 6,3	10	021 032 41	15	40 07157 63005 6
1 x	Impact PZ 1	50 mm	E 6,3	10	031 015 41	18	40 07157 63025 4
1 x	Impact PZ 2	50 mm	E 6,3	10	031 025 41	18	40 07157 63027 8
1 x	Impact PZ 3	50 mm	E 6,3	10	031 035 41	19	40 07157 63029 2



2 x	Impact PH 1	25 mm	C 6,3	10	022 012 41	13	40 07157 62995 1
2 x	Impact PH 2	25 mm	C 6,3	10	022 022 41	13	40 07157 62997 5
2 x	Impact PH 3	25 mm	C 6,3	10	022 032 41	15	40 07157 62999 9
1 x	Impact PH 1	50 mm	E 6,3	10	032 015 41	18	40 07157 63019 3
1 x	Impact PH 2	50 mm	E 6,3	10	032 025 41	18	40 07157 63021 6
1 x	Impact PH 3	50 mm	E 6,3	10	032 035 41	19	40 07157 63023 0



2 x	Impact Torx® 10	25 mm	C 6,3	10	026 102 41	13	40 07157 63007 0
2 x	Impact Torx® 15	25 mm	C 6,3	10	026 152 41	13	40 07157 63009 4
2 x	Impact Torx® 20	25 mm	C 6,3	10	026 202 41	13	40 07157 63011 7
2 x	Impact Torx® 25	25 mm	C 6,3	10	026 252 41	13	40 07157 63013 1
2 x	Impact Torx® 30	25 mm	C 6,3	10	026 302 41	15	40 07157 63015 5
2 x	Impact Torx® 40	25 mm	C 6,3	10	026 402 41	15	40 07157 63017 9
1 x	Impact Torx® 10	50 mm	E 6,3	10	036 105 41	18	40 07157 63031 5
1 x	Impact Torx® 15	50 mm	E 6,3	10	036 155 41	18	40 07157 63033 9
1 x	Impact Torx® 20	50 mm	E 6,3	10	036 205 41	18	40 07157 63035 3
1 x	Impact Torx® 25	50 mm	E 6,3	10	036 255 41	18	40 07157 63037 7
1 x	Impact Torx® 30	50 mm	E 6,3	10	036 305 41	19	40 07157 63039 1
1 x	Impact Torx® 40	50 mm	E 6,3	10	036 405 41	19	40 07157 63041 4



1 x **Bitholder IMPACT 1/4" on Card / Bithalter A.K.**

95 mm E 6,3 10 **038 295 94** 43 40 07157 63077 3



- **secure hold of screw**
- **automatic adjustment to depth of screw head**
- **genuine one-hand operation**
- **quick and easy replacement of bits**
- **compact size.**

- *sicherer Halt der Schraube*
- *automatische Einstellung auf die Tiefe des Schraubenkopfes*
- *echte Einhandbedienung*
- *einfaches und schnelles Wechseln des Bits*
- *kompakte Bauform.*

Making work safer, faster and more efficient !

felo star

*Schraubarbeiten werden sicherer,
schneller und wirtschaftlicher!*

**You can rely on Felo tools
in every job.**

*Auf Felo Werkzeuge ist
in jeder Arbeitssituation
Verlass.*

P. B. K.



038



looking for
innovations?



					Item No		EAN-Code
FeloStar	70 mm	E 6,3	1/4"	6	038 165 90	31	40 07157 50799 0
dto on card / auf Karte							
	70 mm	E 6,3	1/4"	6	038 165 94	37	40 07157 52673 1
FeloStar	150 mm	E 6,3	1/4"	6	038 169 90	55	40 07157 51979 5
FeloStar	450 mm	E 6,3	1/4"	4	038 170 90	128	40 07157 60367 8

TiN 020



			Item No		EAN-Code
AllStar TiN Bit Box Universal C 6,3 x 25 mm		8	020 901 76	147	40 07157 50787 7
Felo Star + 10 TiN Bits					
(2 x)	020:	1,0 x 5,5 / 1,2 x 6,5			
(3 x)	021:	PZ 2			
(1 x)	021:	PZ 3			
(3 x)	022:	PH 2			
(1 x)	022:	PH 3			
(1 x)	038:	Felo Star Automatic Holder / Felo Star Automatikhalter			

TiN 020

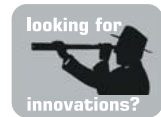

			Item No		EAN-Code
AllStar TiN Bit Box Holz , C 6,3 x 25 mm		8	020 902 76	149	40 07157 50789 1
Felo Star + 10 TiN Bits					
(4 x)	021:	PZ 2			
(1 x)	021:	PZ 3			
(2 x)	026:	Torx® 20			
(1 x)	026:	Torx® 25			
(1 x)	026:	Torx® 30			
(1 x)	026:	Torx® 40			
(1 x)	038:	Felo Star Automatic Holder / Felo Star Automatikhalter			

Torsion 020



			Item No		EAN-Code
AllStar Torsion Bit Box , C 6,3 x 25 mm		8	020 901 06	147	40 07157 63061 2
Felo Star + 10 Torsion Bits					
(2 x)	021:	PZ 2			
(1 x)	021:	PZ 3			
(2 x)	022:	PH 2			
(1 x)	022:	PH 3			
(1 x)	026:	Torx® 20, Torx® 25, Torx® 30, Torx® 40			
(1 x)	038:	Felo Star Automatic Holder / Felo Star Automatikhalter			



020



Item No	EAN-Code
8 020 901 16	40 07157 50793 8

AllStar Bit Box Universal, C 6,3 x 25 mm

Felo Star + 10 Bits

(2 x) **020:** 1,0 x 5,5 / 1,2 x 6,5

(3 x) **021:** PZ 2

(1 x) **021:** PZ 3

(3 x) **022:** PH 2

(1 x) **022:** PH 3

(1 x) **038:** **Felo Star Automatic Holder / Felo Star Automatikhalter**



020



Item No	EAN-Code
8 020 902 16	40 07157 50795 2

AllStar Bit Box Holz, C 6,3 x 25 mm

Felo Star + 10 Bits

(4 x) **021:** PZ 2

(1 x) **021:** PZ 3

(2 x) **026:** Torx® 20

(1 x) **026:** Torx® 25

(1 x) **026:** Torx® 30

(1 x) **026:** Torx® 40

(1 x) **038:** **Felo Star Automatic Holder / Felo Star Automatikhalter**



TiN
026



Item No	EAN-Code
8 020 904 76	40 07157 51011 2

AllStar C 6,3 x 25 mm

Felo Star + 10 TiN Bits

(2 x) **022:** PH 2

(2 x) **021:** PZ 2

(1 x) **021:** PZ 3

(2 x) **026:** Torx® 20

(1 x) **026:** Torx® 25

(1 x) **026:** Torx® 30

(1 x) **026:** Torx® 40

(1 x) **038:** **Felo Star Automatic Holder / Felo Star Automatikhalter**



felo
swift

- All sizes at one glance • easy selection of bits by pick and pull (one-hand operation) • auxiliary screwdriver function
- Bit-Größen auf einen Blick • einfaches Entnehmen (Einhandbedienung) • Funktion als Hilfsschraubendreher



020



	Item No		EAN-Code
TiN Universal Box Swift C 6,3 x 25 mm	10	020 601 76	72 40 07157 51383 0
6 TiN Bits + Bitholder / Magnethalter			
[2 x] 020: 1,0 x 5,5 / 1,2 x 6,5			
[2 x] 021: PZ 1 / PZ 2			
[2 x] 022: PH 1 / PH 2			
[1 x] 038: Bitholder / Magnethalter			
PZ TiN Box Swift C 6,3 x 25 mm	10	020 602 76	72 40 07157 51385 4
6 TiN Bits + Bitholder / Magnethalter			
[2 x] 021: PZ 1			
[3 x] 021: PZ 2			
[1 x] 021: PZ 3			
[1 x] 038: Bitholder / Magnethalter			
dto. on card / auf Karte	10	020 602 71	84 40 07157 52727 1

TiN 020



Item No



EAN-Code



PH - PZ TiN Box Swift C 6,3 x 25 mm

10

020 603 76

72

40 07157 51387 8

6 TiN Bits + Bitholder / Magnethalter

(3 x) **021:** PZ 1 / PZ 2 / PZ 3

(3 x) **022:** PH 1 / PH 2 / PH 3

(1 x) **038:** **Bitholder / Magnethalter**

dto. on card / auf Karte

10

020 603 71

84

40 07157 52729 5



Torx TiN Box Swift C 6,3 x 25 mm

10

020 604 76

73

40 07157 51389 2

6 TiN Bits + Bitholder / Magnethalter

(6 x) **026:** Torx® 10 / 15 / 20 / 25 / 30 / 40

(1 x) **038:** **Bitholder / Magnethalter**

dto. on card / auf Karte

10

020 604 71

84

40 07157 52731 8



Swift TiN Bit-Box C 6,3 x 25 mm

10

020 605 76

71

40 07157 51411 0

6 TiN Bits + Bitholder / Magnethalter

(3 x) **021:** PZ 1 / PZ 2 / PZ 3

(3 x) **026:** Torx® 15 / 20 / 25

(1 x) **038:** **Bitholder / Magnethalter**



Diamant Swift Bit-Box C 6,3 x 25 mm

10

020 603 86

70

40 07157 51707 4

6 Diamant Bits + Bitholder / Magnethalter

(3 x) **021:** PZ 1 / PZ 2 / PZ 3

(3 x) **022:** PH 1 / PH 2 / PH 3

(1 x) **038:** **Bitholder / Magnethalter**

dto. on card / auf Karte

10

020 603 81

82

40 07157 52735 6

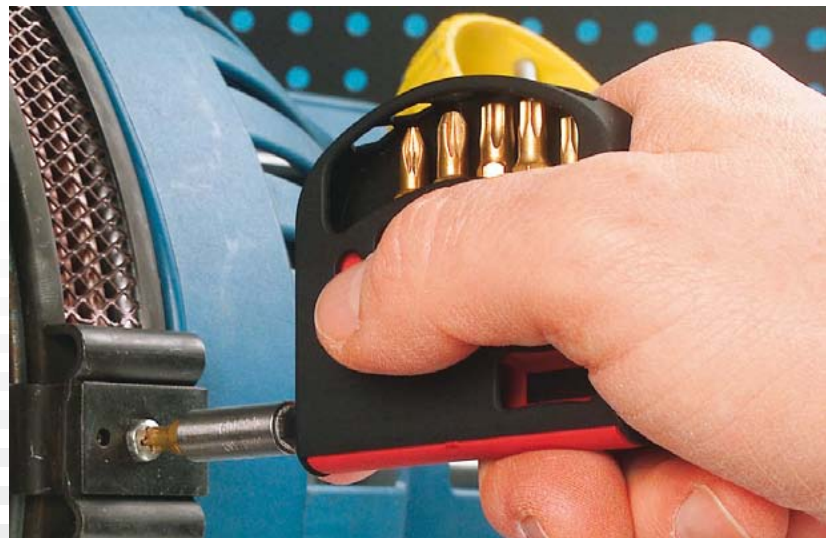

020



Item No



EAN-Code

Box Swift C 6,3 x 25 mm 10 **020 601 16** 72 40 07157 51391 5

6 Bits + Bitholder / Magnethalter

(2 x) **020:** 1,0 x 5,5 / 1,2 x 6,5

(2 x) **021:** PZ 1 / PZ 2

(2 x) **022:** PH 1 / PH 2

(1 x) **038:** **Bitholder / Magnethalter**

PZ Box Swift C 6,3 x 25 mm 10 **020 602 16** 72 40 07157 51393 9

6 Bits + Bitholder / Magnethalter

(2 x) **021:** PZ 1

(3 x) **021:** PZ 2

(1 x) **021:** PZ 3

(1 x) **038:** **Bitholder / Magnethalter**

Torx Box Swift C 6,3 x 25 mm 10 **020 603 16** 73 40 07157 51395 3

6 Bits + Bitholder / Magnethalter

(6 x) **026:** Torx® 10 / 15 / 20 / 25 / 30 / 40

(1 x) **038:** **Bitholder / Magnethalter**

PZ/PH Swift Box C 6,3 x 25 mm 10 **020 603 26** 72 40 07157 51689 3

6 Bits + Bitholder / Magnethalter

(3 x) **021:** PZ 1 / PZ 2 / PZ 3

(3 x) **022:** PH 1 / PH 2 / PH 3

(1 x) **038:** **Bitholder / Magnethalter**



Item No



EAN-Code

Bit-Tool on blister / in Blister C 6,3 x 25 mm 10 **020 801 06** 152 40 07157 63427 6

8 Bits + Bitholder / Magnethalter

(1 x) **020:** 0,8 x 5,5

(1 x) **021:** PZ2

(3 x) **022:** PH1 / 2 / 3

(3 x) **026:** Torx® 15 / 20 / 25

(1 x) **038:** **Bitholder / Magnethalter (58 mm)**



020





Torsion 020



		Item No		EAN-Code
Torx Torsion Box Swift C 6,3 x 25 mm	10	020 601 06	68	40 07157 63043 8
6 Torsion Bits + Bitholder / <i>Magnethalter</i>				
{6 x } 026: Torx® 10 / 15 / 20 / 25 / 30 / 40				
{1 x } 038: Bitholder / <i>Magnethalter</i>				



PZ / Torx Torsion Box Swift C 6,3 x 25 mm	10	020 602 06	68	40 07157 63045 2
6 Torsion Bits + Bitholder / <i>Magnethalter</i>				
{3 x } 021: PZ 1 / PZ 2 / PZ 3				
{3 x } 026: Torx® 15 / 20 / 25				
{1 x } 038: Bitholder / <i>Magnethalter</i>				



PZ Torsion Box Swift C 6,3 x 25 mm	10	020 603 06	67	40 07157 63047 6
6 Torsion Bits + Bitholder / <i>Magnethalter</i>				
{2 x } 021: PZ 1				
{3 x } 021: PZ 2				
{1 x } 021: PZ 3				
{1 x } 038: Bitholder / <i>Magnethalter</i>				



PH Torsion Box Swift C 6,3 x 25 mm	10	020 604 06	67	40 07157 63049 0
6 Torsion Bits + Bitholder / <i>Magnethalter</i>				
{2 x } 022: PH 1				
{3 x } 022: PH 2				
{1 x } 022: PH 3				
{1 x } 038: Bitholder / <i>Magnethalter</i>				



Impact 020



Universal Impact Box Swift C 6,3 x 25 mm



Item No



EAN-Code

10

020 601 46

66

40 07157 63051 3

6 Impact Bits + Bitholder / Magnethalter



(2 x) **021:** PZ 1 / PZ 2



(1 x) **022:** PH 2



(3 x) **026:** Torx® 15 / 20 / 25

(1 x) **038:** **Bitholder / Magnethalter**



PZ / Torx Impact Box Swift C 6,3 x 25 mm

10

020 602 46

68

40 07157 63053 7

6 Impact Bits + Bitholder / Magnethalter



(3 x) **021:** PZ 1 / PZ 2 / PZ 3



(3 x) **026:** Torx® 15 / 20 / 25

(1 x) **038:** **Bitholder / Magnethalter**



Torx Impact Box Swift C 6,3 x 25 mm

10

020 603 46

68

40 07157 63055 1

6 Impact Bits + Bitholder / Magnethalter

(6 x) **026:** Torx® 10 / 15 / 20 / 25 / 30 / 40

(1 x) **038:** **Bitholder / Magnethalter**



PZ Impact Box Swift C 6,3 x 25 mm

10

020 604 46

67

40 07157 63057 5

6 Impact Bits + Bitholder / Magnethalter

(2 x) **021:** PZ 1

(3 x) **021:** PZ 2

(1 x) **021:** PZ 3

(1 x) **038:** **Bitholder / Magnethalter**



PH Impact Box Swift C 6,3 x 25 mm

10

020 605 46

67

40 07157 63059 9

6 Impact Bits + Bitholder / Magnethalter

(2 x) **022:** PH 1

(3 x) **022:** PH 2

(1 x) **022:** PH 3

(1 x) **038:** **Bitholder / Magnethalter**



020



Item No



EAN-Code

		1	020 735 16	365	40 07157 61567 1
Bits 35	35-pce/35-tlg.				
(28 x)	Bits C6,3 x 25mm				
	4,5 x 0,6/ 5,5 x 0,8/ 6,5 x 1,2				
	3mm/ 4mm/ 5mm				
	PH0/ 2 x PH1/ 2 x PH2/ PH3				
	2 x PZ1 /3 x PZ2/ PZ3				
	Torx® 5/ 6/ 7/ 8/ 10/ 15/ 20/ 25/ 30/ 40				
(6 x)	Bits E6,3 x 50mm				
	PZ1/ PZ2				
	PH2				
	Torx® 20/ Torx 25/ Torx 30				
(1 x)	Bitholder / Bithalter E6,3 x 58mm				
	StrongBox 135mm x 75mm x 37mm				

Neu!





		1	020 735 26	365	40 07157 63529 7
Bits 35 Torx®	35-pce/35-tlg.				
(28 x)	Bits C6,3 x 25mm				
	1 x Torx® 5/ 1 x Torx® 6/ 1 x Torx® 7/ 1 x Torx® 8/ 1 x Torx® 9				
	2 x Torx® 10/ 4 x Torx® 15/ 4 x Torx® 20/ 4 x Torx® 25				
	1 x Torx® 27/ 4 x Torx® 30/ 4 x Torx® 40				
(6 x)	Bits E6,3 x 50mm				
	Torx® 10/ 15/ 20/ 25/ 30/ 40				
(1 x)	Bitholder / Bithalter E6,3 x 58mm				
	StrongBox 135mm x 75mm x 37mm				



See also page 125 /
siehe auch Seite 125

020



			Item No		EAN-Code
IMPACT 19	19-pce/19-tlg.	1	020 719 46	262	40 07157 63187 9
(18 x)	IMPACT Bits C6,3 x 25mm				
	1 x PZ1 / 2 x PZ2/ 2 x PZ3				
	1 x PH1/ 2 x PH2/ 2 x PH3				
	1 x Torx® 10 / 1 x Torx® 15 / 1 x Torx® 20				
	2 x Torx® 25 / 2 x Torx® 30 / 1 x Torx® 40				
(1 x)	Bitholder IMPACT / Bithalter IMPACT E6,3 x 58mm				
	StrongBox 135mm x 75mm x 37mm				





Bitbox IMPACT 19 Industry	19-pce/19-tlg.	1	020 719 06	260	40 07157 63555 6
(18 x)	Industry Bits C6,3 x 25mm				
	1 x PZ 1 / 2 x PZ 2/ 2 x PZ 3				
	1 x PH 1/ 2 x PH 2/ 2 x PH 3				
	1 x Torx® 10 / 1 x Torx® 15 / 1 x Torx® 20				
	2 x Torx® 25 / 2 x Torx® 30 / 1 x Torx® 40				
(1 x)	Bitholder IMPACT / Bithalter IMPACT E6,3 x 58mm				
	StrongBox 135mm x 75mm x 37mm				



020



			Item No		EAN-Code
Bit-Tool IMPACT on blister / in Blister	C 6,3 x 25 mm	10	020 802 46	193	40 07157 63429 0
8 Bits + IMPACT Bitholder / IMPACT Bithalter + Bitholder / Magnethalter					
(1 x) 026:	Torx® 10				
(1 x) 026:	Torx® 15				
(1 x) 026:	Torx® 20				
(2 x) 026:	Torx® 25				
(2 x) 026:	Torx® 30				
(1 x) 026:	Torx® 40				
(1 x) 038:	IMPACT Bitholder / Bithalter				
(1 x) 038:	Bitholder / Magnethalter (58 mm)				

Impact 036



Profi Bit Box Impact,



Item No



EAN-Code

10

036 915 46

65

40 07157 63063 6

6 Impact Bits E 6,3 x 50 mm

(6 x) **036:** Torx® 10 / 15 / 20 / 25 / 30 / 40



Profi Bit Box Impact,

10

036 925 46

65

40 07157 63065 0

6 Impact Bits E 6,3 x 50 mm

(2 x) **031:** PZ 1 / PZ 2

(1 x) **032:** PH 2

(3 x) **036:** Torx® 15 / 20 / 25



Profi Bit Box Impact,

10

036 935 46

65

40 07157 63067 4

6 Impact Bits E 6,3 x 50 mm

(1 x) **031:** PZ 2

(1 x) **032:** PH 2

(4 x) **036:** Torx® 15 / 20 / 25 / 30



Profi Bit Box Impact,

10

036 945 46

66

40 07157 63425 2

6 Impact Bits E 6,3 x 50 mm

(2 x) **031:** PZ 2 / 3

(4 x) **036:** Torx® 15 / 20 / 25 / 30



Item No



EAN-Code

10

020 917 16

107

40 07157 31445 1

Profi Bit Box, 12TiN Bits + Bitholder C 6,3 x 25 mm

(4 x) **020:** 0,8 x 5,0 / 1,0 x 5,5 / 1,2 x 6,5 / 1,2 x 8,0

(2 x) **021:** PZ 1 / PZ 3

(2 x) **021:** PZ 2

(2 x) **022:** PH 1 / 3

(2 x) **022:** PH 2

(1 x) **038:** **Bitholder** / Magnethalter 58 mm



TiN 020



TiN 021



	Item No		EAN-Code
Profi Bit Box, 12TiN Bits + Bitholder C 6,3 x 25 mm	10 021 910 76	104	40 07157 31537 3
(2 x) 021: PZ 1			
(8 x) 021: PZ 2			
(2 x) 021: PZ 3			
(1 x) 038: Bitholder / Magnethalter 58 mm			



Profi Bit Box, 12TiN Bits + Bitholder C 6,3 x 25 mm	10 022 910 76	104	40 07157 31408 6
(2 x) 021: PZ 1			
(3 x) 021: PZ 2			
(1 x) 021: PZ 3			
(2 x) 022: PH 1			
(3 x) 022: PH 2			
(1 x) 022: PH 3			
(1 x) 038: Bitholder / Magnethalter 58 mm			



TiN 032



	Item No		EAN-Code
Profi Bit Box, 6 TiN Bits E 6,3 x 50 mm	10 032 915 76	79	40 07157 31413 0
(3 x) 031: PZ 1 / PZ 2 / PZ 3			
(3 x) 032: PH 1 / PH 2 / PH 3			



TiN 036



	Item No		EAN-Code
Profi Bit Box, 6 TiN Bits E 6,3 x 50 mm	10 036 915 76	75	40 07157 32384 2
(6 x) 036: Torx® 10 / Torx® 15 / Torx® 20 Torx® 25 / Torx® 30 / Torx® 40			

020



Item No



EAN-Code

	Item No	Quantity	EAN-Code
Profi Bit Box, 12 Bits + Bitholder C 6,3 x 25 mm	10	107	40 07157 31405 5
(4 x) 020:			0,8 x 5,0 / 1,0 x 5,5 / 1,2 x 6,5 / 1,2 x 8,0
(2 x) 021:			PZ 1 / PZ 3
(2 x) 021:			PZ 2
(2 x) 022:			PH 1 / PH 3
(2 x) 022:			PH 2
(1 x) 038:			Bitholder / Magnethalter 58 mm

022



Item No



EAN-Code

	Item No	Quantity	EAN-Code
Profi Bit Box, 12 Bits + Bitholder C 6,3 x 25 mm	10	104	40 07157 31407 9
(2 x) 021:			PZ 1
(3 x) 021:			PZ 2
(1 x) 021:			PZ 3
(2 x) 022:			PH 1
(3 x) 022:			PH 2
(1 x) 022:			PH 3
(1 x) 038:			Bitholder / Magnethalter 58 mm

026



Item No



EAN-Code

	Item No	Quantity	EAN-Code
Profi Bit Box, 12 Bits + Bitholder C 6,3 x 25 mm	10	104	40 07157 31409 3
(10 x) 026:			Torx® 6 / 7 / 8 / 9 / 10 / 15 / 20 / 27 / 30 / 40
(2 x) 026:			Torx® 25
(1 x) 038:			Bitholder / Magnethalter 58 mm



030





		Item No		EAN-Code
Profi Bit Box, 6 Bits E 6,3 x 50 mm	10	030 915 16	78	40 07157 31410 9
(6 x) 030:		0,6 x 3,5 / 0,8 x 4,0 / 0,8 x 5,0		
		1,0 x 5,5 / 1,2 x 6,5 / 1,2 x 8,0		



032





		Item No		EAN-Code
Profi Bit Box, 6 Bits E6,3 x50mm	10	032 915 16	78	40 07157 31412 3
(3 x) 031:		PZ 1 / PZ 2 / PZ 3		
(3 x) 032:		PH 1 / PH 2 / PH 3		



036



		Item No		EAN-Code
Profi Bit Box, 6 Bits E 6,3 x 50 mm	10	036 915 16	75	40 07157 31419 2
(6 x) 036:		Torx® 10 / Torx® 15 / Torx® 20		
		Torx® 25 / Torx® 30 / Torx® 40		



**Assortments for Electricians/
Sortimente für Elektriker**

030



Item No



EAN-Code

Profi Bit Box, 6 Bits E 6,3 x 50 mm	10	030 925 16	75	40 07157 63075 9
(3 x) 030: 0,5 x 3,0 / 0,8 x 4,0 / 5,5 x 1,0				
(1 x) 031: PZ 2				
(2 x) 032: PH 1 / PH 2				



**Assortments for Electricians/
Sortimente für Elektriker**

030



Item No



EAN-Code

Profi Bit Box, 6 Bits E 6,3 x 73 mm	10	030 927 16	100	40 07157 63069 8
(3 x) 030: 0,5 x 3,0 / 0,8 x 4,0 / 5,5 x 1,0				
(1 x) 031: PZ 2				
(2 x) 032: PH 1 / PH 2				



**Assortments for Electricians/
Sortimente für Elektriker**



031



Item No



EAN-Code

Profi Bit Box, 6 Bits E 6,3 x 73 mm	10	031 927 16	100	40 07157 63071 1
(3 x) 030: 0,5 x 3,0 / 0,8 x 4,0 / 5,5 x 1,0				
(2 x) 031: Z(+/-) 1 / Z(+/-) 2				
(1 x) 032: PH 2				





Assortments for Electricians/ Sortimente für Elektriker



032





		Item No		EAN-Code
Profi Bit Box, 6 Bits E 6,3 x 73 mm	10	032 927 16	100	40 07157 63071 1
(3 x) 030:		0,5 x 3,0 / 0,8 x 4,0 / 5,5 x 1,0		
(2 x) 031:		H(+/-) 1 / H(+/-) 2		
(1 x) 032:		PH 2		



030





		Item No		EAN-Code
Profi Bit Box, 5 Bits E 6,3 x 73 mm	10	030 917 16	83	40 07157 31411 6
(5 x) 030:		0,5 x 3,0 / 0,6 x 3,5 / 0,8 x 4,0 1,0 x 5,5 / 1,2 x 6,5		



032



		Item No		EAN-Code
Profi Bit Box, 6 Bits E 6,3 x 73 mm	10	032 917 16	112	40 07157 31385 0
(3 x) 031:		PZ 1 / PZ 2 / PZ 3		
(3 x) 032:		PH 1 / PH 2 / PH 3		



036



Item No



EAN-Code

Profi Bit-Box, 6 Bits E 6,3 x 73 mm

10

036 917 16

100

40 07157 31417 8

(6 x) **036:** Torx® 10 / Torx® 15 / Torx® 20

Torx® 25 / Torx® 30 / Torx® 40



020



Item No

EAN-Code

Schraub-Box, 9 Bits + Bitholder C 6,3 x 25 mm

6

020 995 06

110

40 07157 30158 1

(3 x) **020:** 0,8 x 5,0 / 1,0 x 5,5 / 1,2 x 7,0

(3 x) **021:** PZ 1 / PZ 2 / PZ 3

(3 x) **022:** PH 1 / PH 2 / PH 3

(1 x) **038:** **Bitholder** / *Magnethalter 58 mm*



057



Item No



EAN-Code

1/4" Nuss-Box, 8 Steckschlüssel + Adapter

6

057 981 06

172

40 07157 22198 8

(8 x) 4 mm / 5 mm / 5,5 mm / 6 mm / 7 mm

8 mm / 10 mm / 13 mm

(1 x) **097:** **Adapter** (Art.No. 097 013 10)



020



Item No



EAN-Code

		6	020 026 16	196	40 07157 50801 0
Bit Box, 25 Bits + Bitholder	C 6,3 x 25 mm				
(10 x) 026:	Torx® 6 / 8 / 9 / 10 / 15 / 20 / 25 / 27 / 30 / 40				
(3 x) 021:	PZ1 / 2 / 3				
(3 x) 022:	PH1 / 2 / 3				
(3 x) 020:	0,8 x 4,0 / 1,0 x 5,5 / 1,2 x 6,5				
(6 x) 024:	2,0 mm / 2,5 mm / 3,0 mm / 4,0 mm / 5,0 mm / 6,0 mm				
(1 x) 038:	Bitholder / <i>Magnethalter 58 mm</i>				



020



Item No



EAN-Code

		6	020 126 16	195	40 07157 50805 8
Bit Box Holz, 25 Bits + Bitholder	C 6,3 x 25 mm				
(5 x) 026:	Torx® 10 / 15 / 27 / 30 / 40				
(2 x 3)	Torx® 20 / Torx® 25				
(2 x 3) 021:	PZ 1 / PZ 3				
(8 x)	PZ 2				
(1 x) 038:	Bitholder / <i>Magnethalter 58 mm</i>				



021



Item No



EAN-Code

		6	021 026 16	194	40 07157 50807 2
Bit Box PZ, 25 Bits + Bitholder	C 6,3 x 25 mm				
(2 x) 021:	PZ 0				
(8 x)	PZ 1				
(12 x)	PZ 2				
(3 x)	PZ 3				
(1 x) 038:	Bitholder / <i>Magnethalter 58 mm</i>				

020



Item No



EAN-Code

	Item No		EAN-Code
Security Bit Box + Bitholder	6 020 326 16	196	40 07157 51565 0
(2 x) 024: SW 4,0 / 3,0			
(3 x) 028: XZN M6 / XZN M5 / XZN M4			
(5 x) 029: TS 10 / TS 8 / TS 6 / TS 4 / TS 0			
(5 x) 027: Torx®TR 30 / Torx®TR 25 / Torx®TR 20 / Torx®TR 15 / Torx®TR 10			
(5 x) 029: Tri-Wing 5 / 4 / 3 / 2 / 1			
(3 x) 020: Spanner 6 / 8 / 10			
(2 x) 028: Clutch 5/32, 1/4			
(1 x) 038: Bitholder / Magnethalter 58 mm			



020



Item No



EAN-Code

	Item No		EAN-Code
Bit-Box, 6 Bits + Bitholder C 6,3 x 25 mm	10 020 974 60	95	40 07157 30141 3
(2 x) 020: 0,8 x 5,0 / 1,2 x 7,0			
(2 x) 021: PZ 1 / PZ 2			
(2 x) 022: PH 1 / PH 2			
(1 x) 038: Bitholder / Magnethalter 58 mm			
Torx-Box, 6 Bits + Bitholder C 6,3 x 25 mm	10 023 974 60	95	40 07157 30251 9
(6 x) 026: Torx® 10 / Torx® 15 / Torx® 20			
Torx® 25 / Torx® 30 / Torx® 40			
(1 x) 038: Bitholder / Magnethalter 58 mm			
dto. on card / auf Karte	10 023 974 61	104	40 07157 30252 6



Special Bits & Adapters

**029
C 6,3**



LocTec®					Item No		EAN-Code
3	25	C 6,3	1/4"	10	029 300 10	5	40 07157 60379 1
4	25	C 6,3	1/4"	10	029 400 10	5	40 07157 60381 4
5	25	C 6,3	1/4"	10	029 500 10	6	40 07157 60383 8
6	25	C 6,3	1/4"	10	029 600 10	6	40 07157 60385 2

**079
C 8**

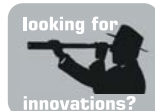

LocTec®					Item No		EAN-Code
8	30	C 8	5/16"	10	079 080 10	11	40 07157 60389 0
10	30	C 8	5/16"	10	079 100 10	11	40 07157 60387 6

Screw in
Einschrauben

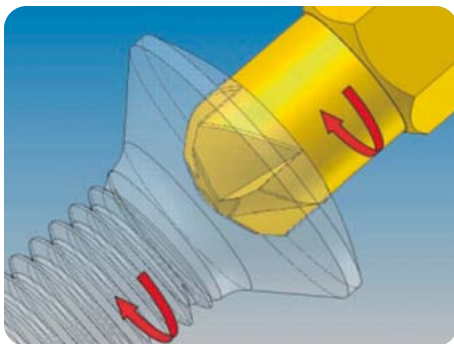

Simply screw in the LocTec® screw with the locking bit. No other locking measures are required.

Die LocTec® Schraube wird einfach mit dem Sicherungsbit verschraubt. Weitere Sicherungsmaßnahmen sind nicht notwendig.

Attempt to loosen the screw
Löseversuch

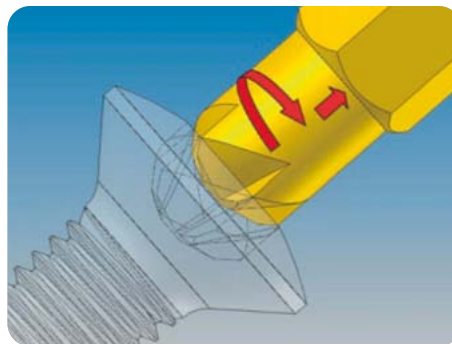

The special flank geometry ensures that any attempt to loosen the screw – even with the locking bit – will fail, since it will merely drive the fitting tool out.

Die spezielle Flankengeometrie sorgt dafür, dass jeglicher Lösungsversuch, auch unter Verwendung des Sicherungsbits, mit dem Herausdrehen des Montagewerkzeuges endet.

For more information visit /

Mehr Information unter:

www.arnold-umformtechnik.de

039
E 6,3



See also page 149
Siehe auch Seite 149



mm				Item No		EAN-Code
5	66 mm	E 6,3	1/4"	5	039 050 10	28 40 07157 50404 3
6	66 mm	E 6,3	1/4"	5	039 060 10	27 40 07157 50406 7
7	66 mm	E 6,3	1/4"	5	039 070 10	26 40 07157 51373 1
8	66 mm	E 6,3	1/4"	5	039 080 10	31 40 07157 50408 1
9	66 mm	E 6,3	1/4"	5	039 090 10	33 40 07157 53245 9
10	66 mm	E 6,3	1/4"	5	039 100 10	36 40 07157 50410 4
12	66 mm	E 6,3	1/4"	5	039 120 10	39 40 07157 53249 7
13	66 mm	E 6,3	1/4"	5	039 130 10	54 40 07157 50412 8

039
E 6,3



				Item No		EAN-Code
5/16"	66 mm	E 6,3	1/4"	5	039 516 10	31 40 07157 50414 2
3/8"	66 mm	E 6,3	1/4"	5	039 038 10	36 40 07157 50416 6

Neu!

039
E 6,3



		Item No		EAN-Code
Nutdriver Bit Set 6-pce / <i>Steckschlüsselbit-Set 6 tlg.</i>	1	039 961 06	550	40 07157 63841 0

6 / 7 / 8 / 10 / 12 / 13 mm

Special Bits for direct fit

Spezial Bits für direkten Maschinenanschluss



A5,5

AEG
BOSCH
HOLZ-HER
KRESS
METABO



G7

BAIER
FEIN



C8

BOSCH
FEIN
HOLZ-HER
LEUREUX
METABO



M5

BÖLLHOFF/
UNIQUICK
HOLZ-HER
WEBER



10/32" NFA

USM
DUOFAST
DVSG

011 A5,5



PZ					Item No		EAN-Code
2	50 mm	A 5,5	5,5 mm	10	011 025 10	10	40 07157 30021 8
3	50 mm	A 5,5	5,5 mm	10	011 035 10	12	40 07157 30023 2

012 A5,5



PH					Item No		EAN-Code
1	50 mm	A 5,5	5,5 mm	10	012 015 10	8	40 07157 30025 6
2	50 mm	A 5,5	5,5 mm	10	012 025 10	10	40 07157 30027 0
3	50 mm	A 5,5	5,5 mm	10	012 035 10	13	40 07157 30029 4

014 A5,5



mm					Item No		EAN-Code
2,5	50 mm	A 5,5	5,5 mm	10	014 255 10	7	40 07157 30031 7
3,0	50 mm	A 5,5	5,5 mm	10	014 305 10	8	40 07157 30033 1
4,0	50 mm	A 5,5	5,5 mm	10	014 405 10	9	40 07157 30035 5
5,0	50 mm	A 5,5	5,5 mm	10	014 505 10	11	40 07157 30037 9
6,0	50 mm	A 5,5	5,5 mm	10	014 605 10	12	40 07157 30039 3

»felo is your specialist with great experience in custom made items and solutions of the highest quality.

»felo ist Ihr erfahrener Spezialist für Sonderanfertigungen und Problemlösungen in höchster Qualität.



061 6,3mm



PZ				Item No		EAN-Code
1/2	60 mm	1/4"	10	061 126 10	13	40 07157 30429 2
2/2	60 mm	1/4"	10	061 226 10	13	40 07157 50522 4
2/3	60 mm	1/4"	10	061 236 10	14	40 07157 30431 5

062 6,3mm



PH				Item No		EAN-Code
1/2	60 mm	1/4"	10	062 126 10	12	40 07157 30433 9
2/2	60 mm	1/4"	10	062 226 10	13	40 07157 50524 8
2/3	60 mm	1/4"	10	062 236 10	13	40 07157 30435 3

063 6,3mm



PH				Item No		EAN-Code
5,5 PH 2	60 mm	1/4"	10	063 255 10	12	40 07157 32556 3

070 C 8



			Item No		EAN-Code	
0,8 x 5,5	32 mm C 8	5/16"	10	070 514 10	8	40 07157 30988 4
1,0 x 5,5	32 mm C 8	5/16"	10	070 524 10	8	40 07157 30989 1
1,0 x 6,0	32 mm C 8	5/16"	10	070 604 10	9	40 07157 30990 7
1,2 x 6,5	32 mm C 8	5/16"	10	070 614 10	9	40 07157 30991 4
1,2 x 8,0	32 mm C 8	5/16"	10	070 804 10	11	40 07157 30992 1
1,6 x 8,0	32 mm C 8	5/16"	10	070 814 10	11	40 07157 30993 8
1,6 x 10,0	38 mm C 8	5/16"	10	070 104 10	17	40 07157 30986 0
2,0 x 12,0	38 mm C 8	5/16"	10	070 204 10	21	40 07157 30987 7

071 C 8



PZ				Item No		EAN-Code
1	32 mm C 8	5/16"	10	071 010 10	9	40 07157 30994 5
2	32 mm C 8	5/16"	10	071 020 10	10	40 07157 30995 2
3	32 mm C 8	5/16"	10	071 030 10	11	40 07157 30996 9
4	38 mm C 8	5/16"	10	071 042 10	17	40 07157 30997 6

072 C 8



PH	→		↕	📦	Item No	📦	EAN-Code
1	32 mm	C 8	5/16"	10	072 010 10	9	40 07157 30998 3
2	32 mm	C 8	5/16"	10	072 020 10	10	40 07157 30999 0
3	32 mm	C 8	5/16"	10	072 030 10	10	40 07157 31000 2
4	38 mm	C 8	5/16"	10	072 042 10	16	40 07157 31001 9

074 C 8



mm	→		↕	📦	Item No	📦	EAN-Code
3	32 mm	C 8	5/16"	10	074 300 10	10	40 07157 31003 3
4	32 mm	C 8	5/16"	10	074 400 10	10	40 07157 31004 0
5	32 mm	C 8	5/16"	10	074 500 10	11	40 07157 31005 7
6	32 mm	C 8	5/16"	10	074 600 10	12	40 07157 31006 4
8	32 mm	C 8	5/16"	10	074 800 10	13	40 07157 31007 1
10	32 mm	C 8	5/16"	10	074 100 10	20	40 07157 31002 6

076 C 8



Torx®	→		↕	📦	Item No	📦	EAN-Code
25	32 mm	C 8	5/16"	10	076 253 10	10	40 07157 31008 8
27	32 mm	C 8	5/16"	10	076 273 10	10	40 07157 31009 5
30	32 mm	C 8	5/16"	10	076 303 10	11	40 07157 31010 1
40	32 mm	C 8	5/16"	10	076 403 10	11	40 07157 31011 8
45	32 mm	C 8	5/16"	10	076 453 10	12	40 07157 31012 5
50	32 mm	C 8	5/16"	10	076 503 10	13	40 07157 31013 2
55	32 mm	C 8	5/16"	10	076 553 10	18	40 07157 31014 9

078 C 8



XZN	→		↕	📦	Item No	📦	EAN-Code
M 5	35 mm	C 8	5/16"	10	078 050 10	11	40 07157 50384 8
M 6	35 mm	C 8	5/16"	10	078 060 10	12	40 07157 50386 2
M 8	35 mm	C 8	5/16"	10	078 080 10	13	40 07157 50388 6
M10	35 mm	C 8	5/16"	10	078 100 10	17	40 07157 50390 9
M12	35 mm	C 8	5/16"	10	078 120 10	22	40 07157 50392 3

078 C 8



XZN	→		↕	📦	Item No	📦	EAN-Code
M 5	120 mm	C 8	5/16"	10	078 005 10	27	40 07157 50394 7
M 6	120 mm	C 8	5/16"	10	078 006 10	48	40 07157 50396 1
M 8	120 mm	C 8	5/16"	10	078 008 10	45	40 07157 50398 5
M 10	120 mm	C 8	5/16"	10	078 010 10	71	40 07157 50400 5
M 12	120 mm	C 8	5/16"	10	078 012 10	95	40 07157 50402 9

081

Gewinde/
Thread



PZ				Item No		EAN-Code
2	44,5 mm	M 5 6 mm	10	081 020 10	9	40 07157 31354 6
2	44,5 mm	10/32" NFA 6 mm	10	081 025 10	8	40 07157 31355 3

082

Gewinde/
Thread



PH				Item No		EAN-Code
2	33 mm	M 5 6 mm	10	082 020 20	6	40 07157 53645 7
2	44,5 mm	M 5 6 mm	10	082 020 10	8	40 07157 31356 0
2	44,5 mm	M 6 6 mm	10	082 225 10	8	40 07157 62407 9
2	44,5 mm	10/32" NFA 6 mm	10	082 025 10	8	40 07157 31357 7

086

Gewinde/
Thread



Torx®				Item No		EAN-Code
20	44,5 mm	M 5 6 mm	10	086 200 10	9	40 07157 31358 4
25	44,5 mm	M 5 6 mm	10	086 250 10	10	40 07157 31359 1
Neu! 20	44,5 mm	M 6 6 mm	10	086 020 10	9	40 07157 63843 4
Neu! 25	44,5 mm	M 6 6 mm	10	086 025 10	10	40 07157 63845 8

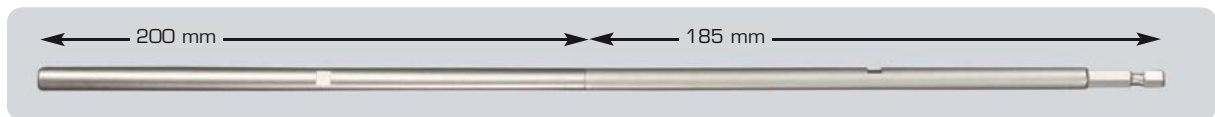

Neu!

086

Gewinde/
Thread



			Item No		EAN-Code
185 mm	M 6 6 mm	1	038 200 10	88	40 07157 63847 2

Adaptor for threaded bits **M6, E 6,3** / Adapter für Innengewinde Bit **M6, E 6,3**

Neu!

086

Gewinde/
Thread

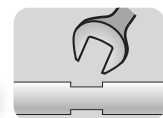

			Item No		EAN-Code
200 mm	M 6 6 mm	1	038 200 20	81	40 07157 63849 6

Extension for adaptor **M6** interior thread **M6** / exterior thread **M6** /

Verlängerung für Adapter **M6** Innengewinde **M6** / Aussengewinde **M6**

Bitholder & Adapters

038
E 6,3



Item No



EAN-Code

Bitholder IMPACT 1/4" / Bithalter IMPACT 1/4"

95 mm

E 6,3

6

038 295 90

43

40 07157 63337 8



429



Item No



EAN-Code

1/4"

170

106

36

6

429 635 40

146

40 07157 60365 4



438

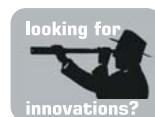

Item No



EAN-Code

1/4"

100

101

33

6

438 125 40

102

40 07157 53711 9

338



Item No



EAN-Code

1/4"

125

100

6

338 125 80

111

40 07157 32350 7

518



AC 1000V
IEC 60900 : 2012



1/4"	105	99	34	6	Item No	107	EAN-Code
					518 125 90		40 07157 50785 3

538

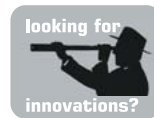

Star-	100	99	34	6	Item No	102	EAN-Code
					538 100 40		40 07157 51397 7

Automatikhalter 1/4"

038



FeloStar	70 mm	E 6,3	1/4"	6	Item No	31	EAN-Code
					038 165 90		40 07157 50799 0
<i>dto on card / auf Karte</i>							
	70 mm	E 6,3	1/4"	6	038 165 94	37	40 07157 52673 1
FeloStar	150 mm	E 6,3	1/4"	6	038 169 90	55	40 07157 51979 5
FeloStar	450 mm	E 6,3	1/4"	1	038 170 90	128	40 07157 60367 8

538



1/4"	100	99	34	6	Item No	102	EAN-Code
					538 125 40		40 07157 32348 4

038



Bitholder extra strong / Magnethalter extra stark					Item No		EAN-Code
	47 mm	E 6,3	1/4"	6	038 109 90	17	40 07157 30850 4
Bitholder / Magnethalter							
	58 mm	E 6,3	1/4"	6	038 103 90	22	40 07157 30340 0
dto. on card / auf Karte				10	038 103 96	30	40 07157 10288 1
Bitholder with retaining ring / Magnethalter mit Sprengring							
	74 mm	E 6,3	1/4"	6	038 102 90	30	40 07157 30337 0
Bitholder with retaining ring / Magnethalter mit Sprengring							
	100 mm	E 6,3	1/4"	6	038 105 90	31	40 07157 50458 6
Bitholder with retaining ring / Magnethalter mit Sprengring							
	150 mm	E 6,3	1/4"	6	038 107 90	44	40 07157 50464 7

018



Bitholder / Magnethalter

60 mm A 5,5 1/4" 6

Item No



EAN-Code

018 102 90

30

40 07157 30043 0

037



Mech. Bithalter

51 mm E 6,3 1/4" 6

Item No



EAN-Code

037 103 90

25

40 07157 32146 8

048

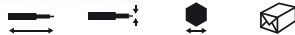

Bitholder with retaining ring / Magnethalter mit Sprengring

60 mm G 7 1/4" 6

Item No



EAN-Code

048 102 80

31

40 07157 32452 8

058

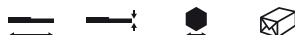

Bitholder / Magnethalter

98 mm SDS 1/4" 6

Item No



EAN-Code

058 102 90

58

40 07157 30978 5

059



depth stop Bit Holder / Tiefenanschlag-Bithalter

max. 79 mm E 6,3 1/4" 6

Item No



EAN-Code

059 103 90

74

40 07157 51897 2



incl. Bit PH 2 x 25

097

1/4" ■



	Item No		EAN-Code
Extension / Verlängerung			
75 mm E 6,3 1/4" 6	097 070 10	45	40 07157 52423 2

097

1/4" ■



	Item No		EAN-Code
Adapter			
25 mm 1/4" C 6,3 6	097 018 10	14	40 07157 30851 1

**397**

	Item No		EAN-Code
T-Handle with square adapter / T-Griff mit 4-Kant Adapter			
1/2" 125 100 6	397 127 80	150	40 07157 62897 8
1/4" 125 100 6	397 635 80	103	40 07157 62899 2
3/8" 125 100 6	397 952 80	135	40 07157 62901 2

097

1/4" ■



	Item No		EAN-Code
Adapter			
50 mm A 5,5 1/4" 6	097 011 10	15	40 07157 30479 7

097

1/4" ■



	Item No		EAN-Code
Adapter			
50 mm E 6,3 1/4" 6	097 013 10	15	40 07157 30481 0
150 mm E 6,3 1/4" 1	097 150 14	62	40 07157 32128 2

097

1/4" ■



	Item No		EAN-Code
Adapter			
50 mm E 6,3 3/8" 6	097 020 10	23	40 07157 30489 6

**finely-serrated jaws
providing firm grip**

*Geräumte Greifflächen für
sicheren Halt am Werkstück*

**induction-hardened cut-
ting edge, 60 / 64 HRC**

*Schneide zusätzlich induktiv
gehärtet, 60 / 64 HRC*

precise joint for optimum leverage

Spelfreies und leichtgängiges Gelenk



**optimum long-lasting
corrosion protection
from special matte
chromium surface**

*optimaler dauerhafter
Oberflächenschutz
durch speziellen
Matt-Chrom*

**Outstanding cutting
performance and
highest precision**

*Optimale Schneidleistung
bei maximaler Präzision*

**Professional quality
for heavy duty use**

Pliers / Zangen

*Profiqualität für
härtesten Einsatz*

Slip-stop wings for secure grip

Abgleitschutz für sicheren Griff

**ergonomically refined design
for maximum comfort**

*ergonomisch ausgereiftes
Design für höchsten
Arbeitskomfort*

**Red/yellow model indivi-
dually tested up to
1000V, VDE IEC 60900**

*Einzelstückprüfung in der
rot-/gelben Ausführung
1000V, VDE IEC 60900*

**superior hardness which
exceeds DIN and ISO
requirements by up to 100%**

*Beste Leistungsdaten,
bis zu 100% über DIN-Werten*



**Socket SystemClip
with safety lanyard**

*Socket für SystemClip
mit Halteschleufe*

**drop-forged
from special steel**

*gesenkgeschmiedet aus
Spezialstahl*

**2-component
handle technology**

*2Komponenten
Grifftechnologie*



GS tested for safety

GS - geprüfte Sicherheit



**EAN code on every
product**

*EAN-Code auf jedem
Werkzeug*

**Quality of Workmanship
and materials guaranteed**

*Garantie auf Verarbeitung
und Material*



Electrician's pliers with multi-functional features for accurate and efficient work at the highest safety standards.

Multifunktionale VDE Zangen für sorgfältige und effiziente Arbeit bei höchstem Sicherheitsstandard.

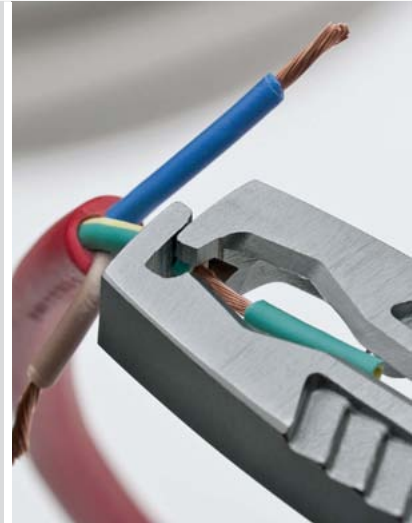

›feLO pliers: Innovation, refined design and exceptional durability

›feLO Zangen: Innovation, durchdachte Details und außergewöhnliche Haltbarkeit

made in Germany



The best pliers German engineering and craftsmanship have produced. Fulfilling the strictest quality requirements.

Entwickelt und hergestellt in Deutschland. Die besten Zangen erfüllen höchste Qualitätsansprüche.



Gripping & cutting: tough work is the ultimate test for perfect tools.

Greifen & Schneiden: harte Arbeit ist der ultimative Test für perfekte Werkzeuge.



Neu!

590



Item No



EAN-Code

165 mm Combination Pliers / Kombizange

6

590 016 40

170

40 07157 63771 0

180 mm Combination Pliers / Kombizange

6

590 018 40

240

40 07157 63773 4

Neu!

591



Item No



EAN-Code

145 mm Diagonal Nippers / Seitenschneider

6

591 014 40

160

40 07157 63775 8

160 mm Diagonal Nippers / Seitenschneider

6

591 016 40

200

40 07157 63777 2

180 mm Diagonal Nippers / Seitenschneider

6

591 018 40

240

40 07157 63779 6

Neu!

591



Item No



EAN-Code

180 mm Heavy-duty Diagonal Nippers

6

591 118 40

245

40 07157 63781 9

180 mm Kraftseitenschneider

Neu!

592



Item No



EAN-Code

205 mm Chain Nose Radio Pliers

6

592 020 40

190

40 07157 63783 3

205 mm Telefonzange (Flachrundzange)

Neu!

592



Item No



EAN-Code

205 mm Chain Nose Radio Plier curved 45°

6

592 220 40

190

40 07157 63783 3

Telefonzange 45° gebogen

Neu!

591



Item No



EAN-Code

200 mm Heavy Duty Lever Side Cutter

6

591 020 40

330

40 07157 63789 5

Telefonzange 45° gebogen

894



DIN ISO 9243



Item No



EAN-Code

210 mm Pincers / Kneifzange

6

894 020 40

365

40 07157 63813 7

Neu!

895



Item No



EAN-Code

250 mm Waterpump Pliers MX

6

895 250 40

340

40 07157 63815 1

250 mm Wasserpumpenzange MX

Neu!

895



Item No



EAN-Code

250 mm Waterpump Pliers Classic

6

895 025 40

350

40 07157 63787 1

Wasserpumpenzange Classic

VDE Pliers / VDE Zangen

Safety Tools Made in Germany.
Sicherheitswerkzeuge Made in Germany.



AC 1000V
IEC 60900 : 2012

**made in
Germany**

Neu!

580



Item No

AC 1000V
IEC 60900 : 2012



EAN-Code

160 mm Combination Pliers VDE/ Kombizange VDE 6

580 016 40

180

40 07157 63791 8

180 mm Combination Pliers VDE/ Kombizange VDE 6

580 018 40

250

40 07157 63793 2

Neu!

581



Item No

AC 1000V
IEC 60900 : 2012



EAN-Code

160 mm Diagonal Nippers VDE/ Seitenschneider 6

581 016 40

210

40 07157 63795 6

180 mm Diagonal Nippers VDE/ Seitenschneider 6

581 018 40

240

40 07157 63797 0

Neu!

582



Item No

AC 1000V
IEC 60900 : 2012



EAN-Code

170 mm Chain Nose Radio Pliers VDE

6

582 017 40

150

40 07157 63799 4

170 mm Telefonzange VDE (Flachrundzange)

Neu!

582



Item No

AC 1000V
IEC 60900 : 2012



EAN-Code

Chain Nose Radio Pliers VDE curved 45° VDE

6

582 225 40

200

40 07157 63801 4

Telefonzange VDE 45° gebogen

Neu!
583



Item No

AC 1000V
IEC 60900 : 2012



EAN-Code



160 mm Insulation Stripping Pliers

6

583 016 40

180

40 07157 63803 8

160 mm Abisolierzange

Neu!
584



Item No

AC 1000V
IEC 60900 : 2012



EAN-Code



Cable Cutter VDE / Kabelschneider VDE

6

584 016 40

305

40 07157 63805 2

Neu!
581



Item No

AC 1000V
IEC 60900 : 2012



EAN-Code



Heavy Duty Diagonal Nippers VDE /

6

581 020 40

305

40 07157 63807 6

Kraftseitenschneider VDE

Neu!
586



Item No

AC 1000V
IEC 60900 : 2012



EAN-Code



Multi Cutter VDE /

6

586 018 40

305

40 07157 63811 3

Multifunktionale Abisolierzange VDE

Neu!
580



Item No



EAN-Code

Safety lanyard with SystemClip /

5

580 001 00

10

40 07157 63851 9

Sicherungsband mit SystemClip

VDE tool sets: perfect equipment for professionals.

VDE Werkzeugsätze: die perfekte Ausrüstung für den Profi

Neu!

413



AC 1000V
IEC 60900 : 2012



Item No



EAN-Code

	VDE Service Kit ERGONIC 11-pcs / Werkzeugtasche VDE11-tlg.	413 911 04	1580	40 07157 63855 7
(3 x)	413:	3,5 x 0,6 / 4,0 x 100 / 5,5 x 1,0		
(3 x)	414:	PH 0 x 60 / PH 1 x 80 / PH 2 x 100		
(1 x)	Mains testing Screwdriver / Spannungsprüfer	3,0 mm x 70 mm (VDE 0680/6, 150-250 Volt)		
(1 x)	Combination Pliers / Kombizange	180 mm		
(1 x)	Diagonal Nippers / Seitenschneider	160 mm		
(1 x)	Chain Nose Radio Pliers VDE / Telefonzange VDE (Flachrundzange)	170 mm		
(1 x)	Cable Stripper / Kabelmesser			
	Nylon bag / Nylon Tasche	330 x 270 x 55 mm		

Neu!

413



AC 1000V
IEC 60900 : 2012



Item No



EAN-Code

	VDE Service Kit E-slim 11-pcs / Werkzeugtasche VDE E-Slim 11-tlg.	413 811 04	1615	40 07157 63857 1
(3 x)	413:	3,5 x 0,6 / 4,0 x 100 / 5,5 x 1,0		
(2 x)	414:	PH 1 x 80 / PH 2 x 100		
(1 x)	415:	PZ 2 x 100		
(1 x)	Mains testing Screwdriver / Spannungsprüfer	3,0 mm x 70 mm (VDE 0680/6, 150-250 Volt)		
(1 x)	Combination Pliers / Kombizange	180 mm		
(1 x)	Diagonal Nippers / Seitenschneider	160 mm		
(1 x)	Chain Nose Radio Pliers VDE / Telefonzange VDE (Flachrundzange)	170 mm		
(1 x)	Cable Stripper / Kabelmesser			
	Nylon bag / Nylon Tasche	330 x 270 x 55 mm		

Neu!

413



AC 1000V
IEC 60900 : 2012



EAN-Code



	Item No		EAN-Code
VDE Belt Pouch 9-pcs / VDE Gürteltasche 9-tlg.	413 995 04	1040	40 07157 63859 5
(3 x) 413: 3,5 x 0,6 / 4,0 x 0,8 / 5,5 x 1,0			
(2 x) 414: PH 1 x 80 / PH 2 x 100			
(1 x) Mains testing Screwdriver / Spannungsprüfer 3,0 mm x 70 mm (VDE 0680/6, 150-250 Volt)			
(1 x) Combination Pliers / Kombizange 180 mm			
(1 x) Diagonal Nippers / Seitenschneider 160 mm			
(1 x) Cable Stripper / Kabelmesser			
Nylon bag / Nylon Tasche 290x 250 x 20 mm			

Neu!

413



AC 1000V
IEC 60900 : 2012

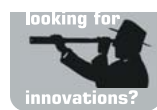

EAN-Code



	Item No		EAN-Code
XL Tool set VDE with pliers and screwdrivers 8-pcs /	413 985 17	1070	40 07157 63853 3
<i>XL Werkzeugsatz VDE mit Zangen und Schraubendrehern 8-tlg.</i>			
(3 x) 413: 3,5 x 0,6 / 4,0 x 0,8 / 5,5 x 1,0			
(2 x) 414: PH 0 x 60 / PH 1 x 80 / PH 2 x 100			
(1 x) 580: Combination Pliers / Kombizange 180 mm			
(1 x) 581: Diagonal Nippers / Seitenschneider 160 mm			

Felo permanent sales displays for individual series and product groups, best sellers and complete assortments demonstrate your competence in tools.

Mit Felo Dauerdisplays für einzelne Serien und Produktgruppen, Bestseller und komplette Sortimente beweisen Sie Werkzeugkompetenz.

Sales presentations
Fachhandel - Präsentationen

Display

Our disposable counter displays can be placed anywhere and are useful for point-of-sale promotions.





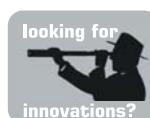











Unsere kleinen, vielseitig platzierbaren Thekendisplays machen Sie flexibel für Aktionen und Kundenansprache im Kassensbereich.





400



		Item No		EAN-Code
Rolldisplay 128-tlg.	(1540 mm / 500 mm / 450 mm)	391 091 00	31000	40 07157 63471 9
400:	3,0 x 80 (5 St./pcs.) / 4,0 x 100 (5 St./pcs.)			
	5,5 x 125 (5 St./pcs.) / 6,5 x 150 (5 St./pcs.) / 8,0 x 175 (5 St./pcs.)			
401:	PZ 1 x 80 (5 St./pcs.) / PZ 2 x 100 (5 St./pcs.)			
402:	PH 1 x 80 (5 St./pcs.) / PH 2 x 100 (5 St./pcs.)			
508:	Torx® 10 x 100 (5 St./pcs) / Torx® 15 x 100 (5 St./pcs)			
	Torx® 20 x 100 (5 St./pcs) / Torx® 25 x 100 (5 St./pcs)			
400 951 18	Ergonic Set (4 St./pcs)			
413:	2,5 x 75 (5 St./pcs.) / 3,5 x 100 (5 St./pcs.)	  	AC 1000V IEC 60900 : 2012	
	4,0 x 100 (5 St./pcs.) / 5,5 x 125 (5 St./pcs.)	  	AC 1000V IEC 60900 : 2012	
414:	PH 1 x 80 (5 St./pcs.) / PH 2 x 100 (5 St./pcs.)	  	AC 1000V IEC 60900 : 2012	
413 961 98	Ergonic Set VDE (4 St./pcs)	  	AC 1000V IEC 60900 : 2012	
063 913 01	E-smart (3 St./pcs)	  	AC 1000V IEC 60900 : 2012	
361 400 01	Mains testing screwdriver / Profi-Spannungsprüfer VDE 0680 150 V – 250 V (6 St./pcs)			
376 041 05	Magazine Handle Bitholder (long) on card / Magazingriff Bithalter (lang) auf Karte (4 St./pcs)			
020 603 71	swift Box TiN (4 St./pcs)			
020 601 11	swift Box Universal (4 St./pcs)			
020 603 11	swift Box Torx® (4 St./pcs)			

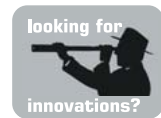

400







	Item No		EAN-Code
Display for 5 ERGONIC Sets / Display für 5 ERGONIC Sätze [230 mm x 120 mm x 440 mm] (5 x) 400 931 18	400 905 10	1970	40 07157 61303 5
Display for 5 ERGONIC Sets VDE / Display für 5 ERGONIC Sätze VDE (5 x) 413 931 94    AC 1000V IEC 60900 : 2012	413 905 90	1680	40 07157 61341 7

Customized selections upon request / Individuelle Zusammenstellungen auf Anfrage



400



	Item No		EAN-Code
Display for 7 ERGONIC Sets / Display für 7 ERGONIC Sätze [280 mm x 265 mm x 450 mm] (7 x) 400 951 18	400 907 10	3800	40 07157 61377 6
Display for 7 ERGONIC Sets VDE / Display für 7 ERGONIC Sätze VDE (7 x) 413 961 98    AC 1000V IEC 60900 : 2012	413 907 90	3895	40 07157 61375 2

Customized selections upon request / Individuelle Zusammenstellungen auf Anfrage

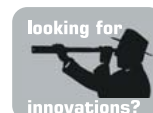

370



Item No



EAN-Code

Display for 12 Magazine Handles / Display für 12 Magazingriffe **376 912 00** 2970 40 07157 61333 2

[280 mm x 265 mm x 450 mm]

[6 x] **374 004 05**

[6 x] **376 041 05**

Customized selections upon request / Individuelle Zusammenstellungen auf Anfrage



400



Item No



EAN-Code

Display for 8 Bit Boxes / Display für 8 Bit Boxen **020 138 70** 926 40 07157 61379 0

[8 x] **020 917 16)**

Customized selections upon request / Individuelle Zusammenstellungen auf Anfrage

Display **ERGONIC**[®]



400



		Item No		EAN-Code
Display 58-tlg.	(460 mm / 350 mm / 210 mm)	400 991 10	6005	40 07157 53703 4
400:	2,5 x 75 (6 St./pcs.) / 3,5 x 100 (6 St./pcs.)			
	4,0 x 100 (6 St./pcs.) / 5,5 x 125 (5 St./pcs.)			
	6,5 x 150 (5 St./pcs.) / 8,0 x 175 (4 St./pcs.)			
401:	PZ 1 x 80 (6 St./pcs.) / PZ 2 x 100 (5 St./pcs.)			
402:	PH 1 x 80 (6 St./pcs.) / PH 2 x 100 (5 St./pcs.)			
	PH 3 x 150 (4 St./pcs.)			
Standard Display 11 Pegs, empty / 11 Haken, leer		391 011 00		

410



		Item No		EAN-Code
Display 63-tlg.	(460 mm / 350 mm / 210 mm)	410 991 40	6277	40 07157 53311 1
410:	4,0 x 75 (6 St./pcs) / 5,5 x 100 (5 St./pcs)			
	6,5 x 125 (5 St./pcs)			
411:	PZ 1 x 80 (6 St./pcs) / PZ 2 x 100 (5 St./pcs)			
412:	PH 1 x 80 (6 St./pcs) / PH 2 x 100 (5 St./pcs)			
413:	3,5 x 100 (8 St./pcs) / 4,0 x 100 (6 St./pcs)			AC 1000V IEC 60900 : 2012
414:	PH 1 x 80 (6 St./pcs) / PH 2 x 100 (5 St./pcs)			AC 1000V IEC 60900 : 2012
Standard Display 11 Pegs, empty / 11 Haken, leer		391 011 00		

400



AC 1000V
IEC 60900 : 2012



		Item No		EAN-Code
Display 61-tlg.	(460 mm / 350 mm / 210 mm)	413 991 90	5336	40 07157 53705 8
413:	2,5 x 75 (6 St./pcs.) / 3,0 x 100 (6 St./pcs.)			
	3,5 x 100 (6 St./pcs.) / 4,0 x 100 (6 St./pcs.)			
	4,5 x 125 (5 St./pcs.) / 5,5 x 125 (5 St./pcs.)			
	6,5 x 150 (5 St./pcs.)			
415:	PZ 2 x 100 (5 St./pcs.)			
414:	PH 0 x 60 (6 St./pcs.) / PH 1 x 80 (6 St./pcs.) / PH 2 x 100 (5 St./pcs.)			
Standard Display 11 Pegs, empty / 11 Haken, leer		391 011 00		

Display Serie 550

550



		Item No		EAN-Code
Display 41-tlg.	(460 mm / 390 mm / 230 mm)	550 993 40	7908	40 07157 53523 8
550:	4,5 x 100 (4 St./pcs.) / 5,5 x 100 (4 St./pcs.)			
	6,5 x 125 (4 St./pcs.) / 8,0 x 155 (4 St./pcs.)			
	10,0 x 175 (3 St./pcs.) / 12,0 x 200 (3 St./pcs.)			
551:	PZ 1 (4 St./pcs.) / PZ 2 (4 St./pcs.)			
552:	PH 1 (4 St./pcs.) / PH 2 (4 St./pcs.)			
	PH 3 (3 St./pcs.)			
Standard Display, empty / Standard Display, leer		391 014 00		

Display Serie 500







500



		Item No		EAN-Code
Display 72-tlg.	(460 mm / 350 mm / 210 mm)	500 992 10	6165	40 07157 50829 4
500:	5,5 x 25 (6 St./pcs) / 3,5 x 100 (8 St./pcs) 4,0 x 100 (7 St./pcs) / 5,5 x 125 (6 St./pcs) 6,5 x 150 (6 St./pcs) / 8,0 x 175 (5 St./pcs)			
501:	PZ 1 x 80 (7 St./pcs) / PZ 2 x 100 (6 St./pcs)			
502:	PH 0 x 60 (8 St./pcs) / PH 1 x 80 (7 St./pcs) PH 2 x 100 (6 St./pcs)			
Standard Display 11 Pegs, empty / 11 Haken, leer		391 011 00		

500



		Item No		EAN-Code
Display 74-tlg.	(460 mm / 350 mm / 210 mm)	500 994 10	6013	40 07157 51709 8
500:	4,0 x 100 (7 St./pcs) / 5,5 x 125 (6 St./pcs) 6,5 x 150 (6 St./pcs)			
501:	PZ 1 x 80 (7 St./pcs) / PZ 2 x 100 (6 St./pcs)			
502:	PH 1 x 80 (7 St./pcs) / PH 2 x 100 (6 St./pcs)			
513:	3,5 x 100 (8 St./pcs) / 4,0 x 100 (8 St./pcs)	  		AC 1000V IEC 60900 : 2012
514:	PH 1 x 80 (7 St./pcs) / PH 2 x 100 (6 St./pcs)	  		AC 1000V IEC 60900 : 2012
Standard Display 11 Pegs, empty / 11 Haken, leer		391 011 00		

500



		Item No		EAN-Code
Display 76-tlg.	(460 mm / 350 mm / 210 mm)	508 912 40	5653	40 07157 51711 1
508:	Torx® 6 x 60 (10 St./pcs) / Torx® 7 x 60 (8 St./pcs)			
	Torx® 8 x 60 (8 St./pcs) / Torx® 9 x 60 (8 St./pcs)			
	Torx® 10 x 100 (7 St./pcs) / Torx® 15 x 100 (7 St./pcs)			
	Torx® 20 x 100 (6 St./pcs) / Torx® 25 x 100 (6 St./pcs)			
	Torx® 27 x 100 (6 St./pcs) / Torx® 30 x 115 (5 St./pcs)			
	Torx® 40 x 125 (5 St./pcs)			
Standard Display 11 Pegs, empty / 11 Haken, leer		391 011 00		

500



AC 1000V
IEC 60900 : 2012

		Item No		EAN-Code
Display 82-tlg.	(460 mm / 350 mm / 210 mm)	513 991 90	5667	40 07157 51863 7
513:	2,5 x 75 (10 St./pcs) / 3,0 x 100 (10 St./pcs)			
	3,5 x 100 (8 St./pcs) / 4,0 x 100 (8 St./pcs)			
	5,5 x 125 (6 St./pcs) / 6,5 x 150 (6 St./pcs)			
514:	PH 0 x 60 (8 St./pcs) / PH 1 x 80 (7 St./pcs)			
	PH 2 x 100 (6 St./pcs)			
515:	PZ 1 x 80 (7 St./pcs) / PZ 2 x 100 (6 St./pcs)			
Standard Display 11 Pegs, empty / 11 Haken, leer		391 011 00		

500



		Item No		EAN-Code
Display 76-tlg. M-TEC	(460 mm / 350 mm / 210 mm)	500 991 30	5967	40 07157 51717 3
500:	3,0 x 80 (8 St./pcs) / 3,5 x 100 (8 St./pcs) 4 x 100 (7 St./pcs)			
501:	PZ 1 x 80 (7 St./pcs) / PZ 2 x 100 (6 St./pcs)			
502:	PH 1 x 80 (7 St./pcs) / PH 2 x 100 (6 St./pcs)			
508:	Torx® 10 x 100 (8 St./pcs) / Torx® 15 x 100 (7 St./pcs) Torx® 20 x 100 (6 St./pcs) / Torx® 25 x 100 (6 St./pcs)			
Standard Display 11 Pegs, empty / 11 Haken, leer		391 011 00		

Display Serie 600

613



AC 1000V
IEC 60900 : 2012

		Item No		EAN-Code
IEC Display 80-tlg.	(460 mm / 350 mm / 210 mm)	613 992 90	5382	40 07157 50837 9
613:	2,5 x 75 (9 St./pcs) / 3,0 x 100 (9 St./pcs) 3,5 x 100 (8 St./pcs) / 4,0 x 100 (7 St./pcs) 5,5 x 125 (6 St./pcs) / 6,5 x 150 (6 St./pcs)			
614:	PH 0 x 60 (9 St./pcs) / PH 1 x 80 (7 St./pcs) PH 2 x 100 (6 St./pcs)			
615:	PZ 1 x 80 (7 St./pcs) / PZ 2 x 100 (6 St./pcs)			
Standard Display 11 Pegs, empty / 11 Haken, leer		391 011 00		

Display Serie 206

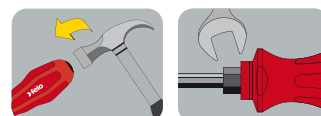

206



Item No



EAN-Code

		Item No		EAN-Code
Display 41-tlg.	(460 mm / 350 mm / 210 mm)	206 992 90	6280	40 07157 57797 9
200:	4,0 x 100 (4 St./pcs)			
206:	5,5 x 100 (4 St./pcs) / 6,5 x 125 (4 St./pcs) 8,0 x 150 (4 St./pcs) / 10,0 x 175 (3 St./pcs) 12,0 x 200 (3 St./pcs)			
201:	PZ 1 x 80 (4 St./pcs)			
216:	PZ 2 x 100 (4 St./pcs)			
202:	PH 1 x 80 (4 St./pcs)			
226:	PH 2 x 100 (4 St./pcs) / PH 3 x 150 (3 St./pcs)			
Standard Display, empty / Standart Display, leer		391 014 00		

Display Serie 200



200



Item No









EAN-Code

		Item No		EAN-Code
Display 75-tlg.	(460 mm / 350 mm / 210 mm)	200 994 90	5438	40 07157 50841 6
200:	3,5 x 100 (8 St./pcs) / 4,0 x 100 (7 St./pcs) 5,5 x 25 (6 St./pcs) / 5,5 x 125 (6 St./pcs) 6,5 x 150 (6 St./pcs)			
201:	PZ 0 x 60 (8 St./pcs) / PZ 1 x 80 (7 St./pcs) PZ 2 x 100 (6 St./pcs)			
202:	PH 0 x 60 (8 St./pcs) / PH 1 x 80 (7 St./pcs) PH 2 x 100 (6 St./pcs)			
Standard Display 11 Pegs, empty / 11 Haken, leer		391 011 00		

200



		Item No		EAN-Code
Display 73-tlg.	(460 mm / 350 mm / 210 mm)	200 997 90	5790	40 07157 51753 1
200:	4,0 x 100 (7 St./pcs) / 5,0 x 125 (6 St./pcs) 6,5 x 125 (6 St./pcs)			
201:	PZ 1 x 80 (7 St./pcs) / PZ 2 x 100 (6 St./pcs)			
202:	PH 1 x 80 (7 St./pcs) / PH 2 x 100 (6 St./pcs)			
613:	3,5 x 100 (8 St./pcs) / 4,0 x 100 (7 St./pcs)	  	AC 1000V IEC 60900 : 2012	
614:	PH 1 x 80 (7 St./pcs) / PH 2 x 100 (6 St./pcs)	  	AC 1000V IEC 60900 : 2012	

Standard Display 11 Pegs, empty / 11 Haken, leer

391 011 00

200



		Item No		EAN-Code
Display 74-tlg.	(460 mm / 350 mm / 210 mm)	208 991 90	5469	40 07157 51755 5
208:	Torx® 6 (8 St./pcs) / Torx® 7 (8 St./pcs) Torx® 8 (8 St./pcs) / Torx® 9 (8 St./pcs) Torx® 10 (7 St./pcs) / Torx® 15 (7 St./pcs) Torx® 20 (6 St./pcs) / Torx® 25 (6 St./pcs) Torx® 27 (6 St./pcs) / Torx® 30 (5 St./pcs) Torx® 40 (5 St./pcs)			

Standard Display 11 Pegs, empty / 11 Haken, leer

391 011 00

Display Serie 240/250



240



	Item No		EAN-Code
Boxen-Display 10-tlg. (220 mm / 290 mm / 250 mm)	240 961 50	3243	40 07157 50018 2
(5 x) 240:	240 961 56		
(5 x) 248:	248 961 56		
Display Boxen 240 empty / leer	391 023 00		



240



	Item No		EAN-Code
Display 48-tlg. (250 mm / 290 mm / 150 mm)	240 990 50	1844	40 07157 31804 6
(4 x 6) 240:	2,5 x 60 / 3,0 x 60		
	3,5 x 100 / 4,0 x 100		
(2 x 6) 241:	PZ 0 x 60 / PZ 1 x 60		
(2 x 6) 242:	PH 0 x 60 / PH 1 x 60		
Display Serie 240, 8 Pegs, empty / 8 Haken, leer	391 020 00		

240



		Item No		EAN-Code
Kombi-Display (220 mm / 290 mm / 250 mm)		240 951 50	2563	40 07157 51703 6
(5 x) 240:	240 961 56			
(6 x) 240:	2,5 x 60 \ 3,5 x 100			
(6 x) 242:	PH 0 x 60			
(6 x) 248:	Torx® 6 x 60			
Kombi-Display, empty / leer		391 023 50		

280



		Item No		EAN-Code
Boxen-Display 10-tlg. (260 mm / 300 mm / 220 mm)		280 961 10	2933	40 07157 50753 2
(5 x) 280:	280 907 06			
(5 x) 280:	280 907 26			

250



ESD Safe
10⁸ - 10¹⁰ Ω



	Item No		EAN-Code
Boxen-Display 10-tlg. (260 mm / 300 mm / 220 mm) (10 x) 250: 250 961 86	250 961 80	3318	40 07157 50296 4

Display Serie 330

330

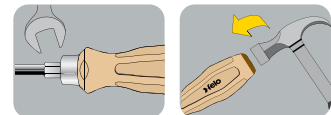

	Item No		EAN-Code
Display 41-tlg. (460 mm / 350 mm / 210 mm)	335 991 90	7450	40 071575 7799 3
(4 x 4) 335: 4,5 x 90 / 5,5 x 100 / 7,0 x 125 / 9,0 x 150			
(2 x 3) 10,0 x 175 / 12,0 x 200			
(2 x 4) 336: PZ 1 x 80 / PZ 2 x 100			
(1 x 3) PZ 3 x 150			
(2 x 4) 337: PH 1 x 80 / PH 2 x 100			
Standard Display, empty / Standart Display, leer	391 014 00		

Display Bits



381



Item No  EAN-Code

Bit Display 177-pce / 177-tlg (460 x 350 x 210mm)			391 818 90	4840	40 07157 63333 0
10 x 020 520 36	2 St./ pcs.	5,5 x 25 mm			
10 x 020 610 36	2 St./ pcs.	6,5 x 25mm			
10 x 020 800 36	2 St./ pcs.	8,0 x 25mm			
10 x 021 010 36	2 St./ pcs.	PZ1 x 25mm			
10 x 021 020 36	2 St./ pcs.	PZ2 x 25mm			
10 x 021 030 36	2 St./ pcs.	PZ3 x 25mm			
10 x 022 010 36	2 St./ pcs.	PH1 x 25mm			
10 x 022 020 36	2 St./ pcs.	PH2 x 25mm			
10 x 022 030 36	2 St./ pcs.	PH2 x 25mm			
10 x 031 025 36	2 St./ pcs.	PZ2 x 50mm			
10 x 032 025 36	2 St./ pcs.	PH2 x 50mm			
10 x 026 100 36	2 St./ pcs.	Torx® 10 x 25mm			
10 x 026 150 36	2 St./ pcs.	Torx® 15 x 25mm			
10 x 026 200 36	2 St./ pcs.	Torx® 20 x 25mm			
10 x 026 250 36	2 St./ pcs.	Torx® 25 x 25mm			
10 x 026 300 36	2 St./ pcs.	Torx® 30 x 25mm			
10 x 026 400 36	2 St./ pcs.	Torx® 40 x 25mm			
7 x 038 103 96	1 St./ pcs.	Bitholder / Magnethalter 58mm			



038



Item No  EAN-Code

Display for Impact Bitholders / Display Impact Bithalter			038 224 90	2208	40 07157 58723 7
24 x 038 295 94 (345 x 245 x 170 mm)					

204



Item No



EAN-Code

Item No	EAN-Code
020 950 06	2129 40 07157 51317 5
Bit-Tray 300-pce/ Zahlteller (275 mm x 270 mm x 33 mm)	
10 x PH 1 x 25 TIN / 20 x PH 2 x 25 TIN / 10 x PH 3 x 25 TIN	
10 x PZ 1 x 25 TIN / 20 x PZ 2 x 25 TIN / 10 x PZ 3 x 25 TIN	
10 x Torx® 10 x 25 TIN / 10 x Torx® 15 x 25 TIN / 10 x Torx® 20 x 25 TIN	
10 x Torx® 25 x 25 TIN / 10 x Torx® 30 x 25 TIN / 10 x Torx® 40 x 25 TIN	
10 x PZ 1 x 25 Diamant / 20 x PZ 2 x 25 DIA	
20 x PH 2 x 25 Diamant / 10 x PH 2 x 50 TIN	
10 x PZ 2 x 50 TIN	
10 x Torx® 15 x 50 TIN / 10 x Torx® 20 x 50 TIN / 10 x Torx® 25 x 50 TIN / 10 x Torx® 30 x 50 TIN	
6 x Adapter 6,3 1/4" 4-kt / 6 x Adapter 3/8" 50mm	
5 x Steckschlüssel Hex 8 x 66 / 5 x Steckschlüssel Hex 10 x 66 / 4 x Steckschlüssel Hex 13 x 66	
12 x Magnethalter 1/4" x 47 / 12 x Magnethalter 1/4" x 58	



Item No



EAN-Code

Item No	EAN-Code
020 951 06	2038 40 07157 51687 9
Bit-Tray 284-pce/ Zahlteller (275 mm x 270 mm x 33 mm)	
10 x PZ 1 x 25 / 20 x PZ 2 x 25 / 10 x PZ 3 x 25	
10 x PH 1 x 25 / 20 x PH 2 x 25 / 10 x PH 3 x 25	
10 x Torx® 15 x 25 / 10 x Torx® 20 x 25 / 10 x Torx® 25 x 25 / 10 x Torx® 30 x 25	
10 x PZ 1 x 25 TIN / 10 x PZ 2 x 25 TIN / 10 x PZ 3 x 25 TIN	
10 x PH 1 x 25 TIN / 10 x PH2 x 25 TIN / 10 x PH 3 x 25 TIN	
10 x PZ 1 x 50 / 10 x PZ 2 x 50	
10 x PH 1 x 50 / 10 x PH 2 x 50	
10 x 0,5 x 4,0 / 10 x 0,6 x 4,5 / 10 x 0,8 x 5,5	
12 x Magnethalter 1/4"	
6 x Adapter 1/4" x 25 mm / 6 x Adapter 3/8" x 50 mm / 6 x Adapter E 6,3 x 50 mm	
4 x Felo Star	

Display **felo star**

038



		Item No		EAN-Code
Felo Star Clipstrip (850 mm x 50 mm)	1	038 012 90	494	40 07157 53049 3
(12 x)	038 165 94			

038

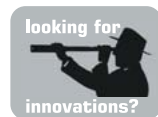

		Item No		EAN-Code
Star Display (345 mm / 245 mm / 170 mm)		038 024 90	1397	40 07157 51431 8
(24 x)	038 165 90			

Neu!

038

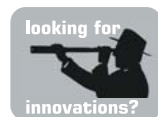

		Item No		EAN-Code
Impact / Star Display 24-pcs 24-tlg		038 124 90	2024	40 07157 63753 6
(12 x)	038 295 90			
(12 x)	038 165 90			

Display **felo** swift



038

			Item No		EAN-Code
Clipstrip Universal	(85 x 10 cm)	1	020 380 00	1058	40 07157 53045 5
{12 x }	020 601 11				
Clipstrip Torx®	(85 x 10 cm)	1	020 382 00	1070	40 07157 53177 3
{12 x }	020 603 11				



020

			Item No		EAN-Code
Holz TiN / Universal TiN		1	020 360 00	2574	40 07157 51529 2
{18 x }	02060576 + 18 x 02060176				
Universal / Torx®		1	020 363 00	2610	40 07157 51535 3
{18 x }	02060116 + 18 x 02060316				
Universal / Universal TiN		1	020 367 00	2748	40 07157 51551 3
{18 x }	02060116 + 18 x 02060176				
PZ PH TiN		1	020 368 00	2784	40 07157 51611 4
{36 x }	02060376				

Display empty / leer

391



Pliers Display / Zangen Display

empty / leer

Item No

391 058 00



1670

391



Bit-Schütte

empty / leer

Item No

391 015 00



4359

391



R-Go / XS Display

empty / leer

Item No

391 010 00



4526

391



AllStar / swift Display

empty / leer

Item No

391 043 00



1088

391



AllStar Display

empty / leer

Item No

391 026 00



981

391



T-Handle Display, per hook / Display T-Griff, pro Haken

empty / leer

Item No

391 024 00



153

Intelligent sales concepts for the specialist trade and ideal product presentation. We will give you professional advice and develop a concept to suit your needs.

*Durchdachte Fachhandels-Konzepte und optimale Präsentationen.
Wir beraten Sie gerne und entwickeln ein auf Sie
abgestimmtes Konzept*



In addition to the products shown below, we have a further 120 tools for professionals and 20 quality pliers in our program.

Neben den unten genannten Artikeln führen wir weitere 120 Profi-Werkzeuge und 20 Qualitäts-Zangen.

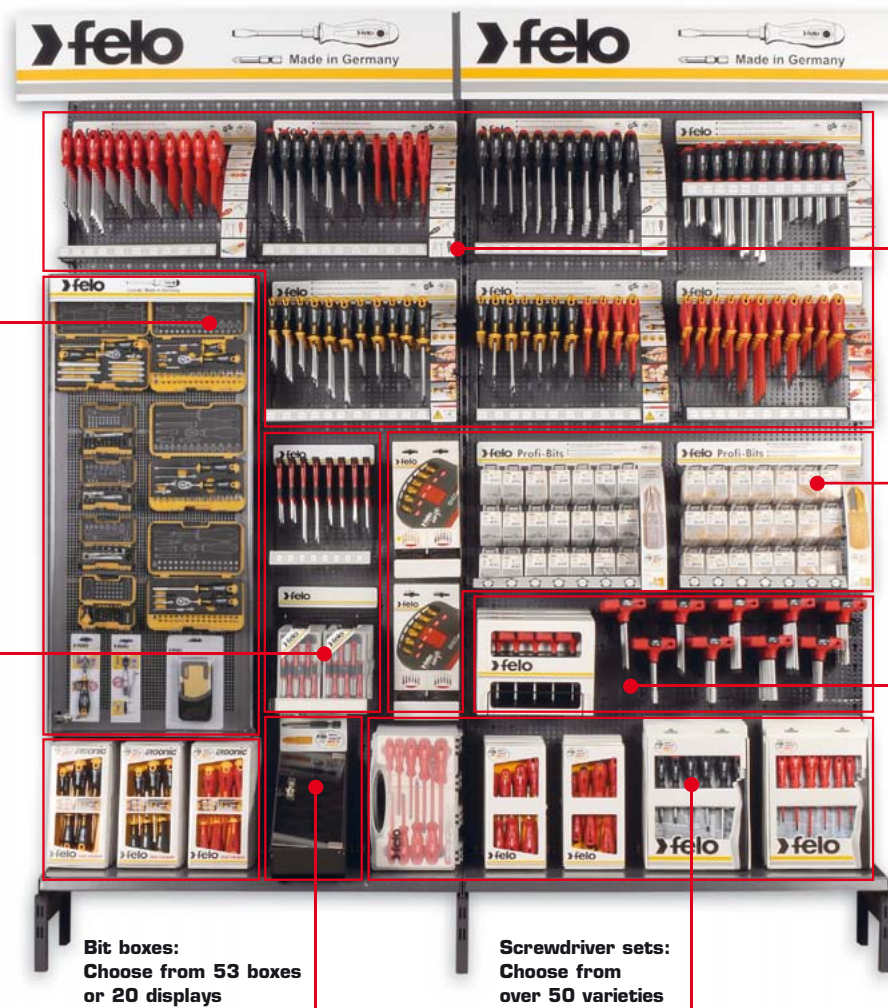

**Combi tools:
Choose from 28 types**
*Kombi-Werkzeuge:
Wählen Sie aus
28 Sortimenten*

**Precision
screwdrivers:
Choose from
60 individual tools,
9 different sets
or 10 displays**
*Präzisions-
Schraubendreher:
Wählen Sie aus
60 Werkzeugen und
9 verschiedenen Sets
oder 10 Displays*

**Bit boxes:
Choose from 53 boxes
or 20 displays**
*Bitboxen:
Wählen Sie aus
53 Boxen und
20 Displays*

**Screwdriver sets:
Choose from
over 50 varieties**
*Schraubendreher-Sätze:
Wählen Sie aus
über 50 Varianten*

**Screwdrivers:
Choose from
400 screwdrivers or
23 filled displays**
*Schraubendreher:
Wählen Sie aus
400 Schraubendrehern
und 23 bestückten
Displays*

**Bits:
Choose from 340 bits
or 50 PP boxes**
*Bits:
Wählen Sie aus
340 Bits und
50 SB-Verpackungen*

**T-handles: Choose
from 40 individual
tools and 2 sets**
*T-Griffe:
Wählen Sie aus
40 Werkzeugen
und 2 Sets*

Retail displays are available as 1m core-assortment modules for intelligent and convincing sales presentation even in limited spaces.

Fachhandels-Sortimente sind auch als 1m Kern-Module erhältlich. Selbst bei geringem Platzangebot überzeugen die durchdachten Warenpräsentationen.



Stickers in various languages informative pictograms clearly explaining product features! Stickers for item numbers and prices

Kopfschilder in Landessprachen und Piktogramme erklären Produktvorteile. Der Kunde wird klar informiert! Auszeichnungstreifen für Preisinformation und Artikelnummer

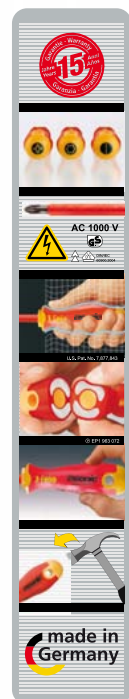

Convincing displays for small items: Our new ready-to-sell bit displays for placement on the sales counter.

Überzeugende Displays für kleine Produkte: Unsere neuen verkaufsfertigen Bit Displays für die Verkaufstheke.



Felo Star
A sure sales booster with innovative products
Displays made of high-quality acrylic glass.

Felo Star:
Eine Garantie für Umsatz mit innovativen Produkten.
Thekendisplays aus hochwertigem Acrylglas.



Convincing POS support going hand in hand with new product lines.

Überzeugende Verkaufsunterstützung die Hand-in-Hand mit neuen Produkten geht.



Your partner for

- **innovative products**
- **extensive variety**
- **highest quality standards**
- **convincing sales support**
- **fast delivery**

Ihr Partner für

- *innovative Produkte*
- *umfassende Sortimentstiefe*
- *höchste Qualitätsstandards*
- *durchdachte Verkaufshilfen*
- *schnellen Lieferservice*

Article Index / Artikel Index

Item No	Page Seite
011 025 10	174
011 035 10	174
012 015 10	174
012 025 10	174
012 035 10	174
014 255 10	174
014 305 10	174
014 405 10	174
014 505 10	174
014 605 10	174
018 102 90	180
020 026 16	170
020 126 16	170
020 138 70	193
020 210 10	136
020 300 10	136
020 310 10	136
020 310 36	148
020 326 16	171
020 360 00	207
020 363 00	207
020 367 00	207
020 368 00	207
020 380 00	207
020 381 00	207
020 382 00	207
020 400 10	136
020 400 80	130
020 410 10	136
020 410 36	148
020 500 10	136
020 500 36	148
020 500 67	147
020 500 70	132
020 510 10	136
020 510 36	148
020 520 10	136
020 520 36	148
020 520 67	147
020 520 70	132
020 520 80	130
020 600 10	136

Item No	Page Seite
020 601 06	158
020 601 16	157
020 601 46	159
020 601 76	155
020 602 06	158
020 602 16	157
020 602 46	159
020 602 71	155
020 602 76	155
020 603 06	158
020 603 16	157
020 603 26	157
020 603 46	159
020 603 71	156
020 603 76	156
020 603 81	156
020 603 86	156
020 604 06	158
020 604 46	159
020 604 71	156
020 604 76	156
020 605 46	159
020 605 76	156
020 610 10	136
020 610 36	148
020 610 67	147
020 610 70	132
020 610 80	130
020 719 06	162
020 719 46	162
020 730 06	160
020 735 16	161
020 735 26	161
020 738 06	160
020 800 10	136
020 800 36	148
020 800 67	147
020 800 70	132
020 800 80	130
020 801 06	125
020 802 46	125
020 901 06	153

Item No	Page Seite
020 901 16	154
020 901 76	153
020 902 16	154
020 902 76	153
020 904 76	154
020 906 10	140
020 908 10	140
020 910 10	140
020 910 16	165
020 912 06	64
020 917 16	163
020 950 06	205
020 951 06	205
020 974 60	171
020 995 06	169
021 000 10	136
021 010 00	129
021 010 10	136
021 010 17	136
021 010 36	148
021 010 40	126
021 010 56	148
021 010 67	147
021 010 70	132
021 010 77	132
021 010 80	130
021 010 86	146
021 012 01	150
021 012 41	151
021 012 86	146
021 015 10	137
021 015 36	148
021 015 56	148
021 020 00	129
021 020 10	136
021 020 17	136
021 020 36	148
021 020 40	126
021 020 56	148
021 020 57	147
021 020 67	147
021 020 70	132

Item No	Page Seite
021 020 76	132
021 020 80	130
021 022 01	150
021 022 41	151
021 022 86	146
021 025 10	137
021 025 36	148
021 025 56	148
021 026 16	170
021 030 00	129
021 030 10	136
021 030 17	136
021 030 36	148
021 030 40	126
021 030 56	148
021 030 67	147
021 030 70	132
021 030 77	132
021 030 80	130
021 030 86	146
021 032 01	150
021 032 41	151
021 032 86	146
021 035 10	137
021 035 36	148
021 035 56	148
021 042 10	136
021 910 76	164
021 932 16	148
021 932 67	147
021 932 86	146
022 000 10	136
022 002 10	137
022 002 70	133
022 010 00	129
022 010 10	136
022 010 17	136
022 010 36	149
022 010 40	126
022 010 56	149
022 010 67	147
022 010 70	132
022 010 77	132
022 010 80	130
022 010 86	146
022 012 01	150
022 012 41	151
022 015 10	137
022 015 36	149
022 015 56	149

Item No	Page Seite
022 020 00	129
022 020 10	136
022 020 17	136
022 020 36	149
022 020 40	126
022 020 56	149
022 020 57	147
022 020 67	147
022 020 70	132
022 020 77	132
022 020 80	130
022 022 01	150
022 022 41	151
022 022 86	146
022 025 10	137
022 025 36	149
022 025 56	149
022 030 00	129
022 030 10	136
022 030 17	136
022 030 36	149
022 030 40	126
022 030 56	149
022 030 67	147
022 030 70	132
022 030 80	130
022 030 86	146
022 032 01	150
022 032 41	151
022 035 10	137
022 035 36	149
022 035 56	149
022 042 10	136
022 910 16	165
022 910 76	164
022 931 16	149
022 931 67	147
022 931 86	146
023 060 10	139
023 070 10	139
023 080 10	139
023 090 10	139
023 100 10	139
023 150 10	139
023 200 10	139
023 250 10	139
023 270 10	139
023 300 10	139
023 400 10	139
023 974 60	171

Item No	Page Seite
023 974 61	171
024 200 10	138
024 200 36	149
024 250 10	138
024 250 36	149
024 300 10	138
024 300 36	149
024 400 10	138
024 400 36	149
024 400 56	149
024 500 10	138
024 500 36	149
024 550 10	138
024 600 10	138
024 600 36	149
024 800 10	138
024 800 36	149
025 000 10	138
025 100 10	138
025 200 10	138
025 300 10	138
026 050 10	138
026 050 36	149
026 060 10	138
026 060 36	149
026 060 70	133
026 070 10	138
026 070 36	149
026 070 70	133
026 080 10	138
026 080 36	149
026 080 70	133
026 090 10	138
026 090 36	149
026 090 70	133
026 100 00	129
026 100 10	138
026 100 17	138
026 100 36	149
026 100 40	126
026 100 67	147
026 100 70	133
026 100 80	131
026 100 86	146
026 102 01	150
026 102 41	151
026 150 00	129
026 150 10	138
026 150 17	138
026 150 36	149

Item No	Page Seite
026 150 40	126
026 150 67	147
026 150 70	133
026 150 77	133
026 150 80	131
026 150 86	146
026 152 01	150
026 152 41	151
026 200 00	129
026 200 10	138
026 200 17	138
026 200 36	149
026 200 40	126
026 200 67	147
026 200 70	133
026 200 77	133
026 200 80	131
026 202 01	150
026 202 41	151
026 202 86	146
026 250 00	129
026 250 10	138
026 250 17	138
026 250 36	149
026 250 40	126
026 250 67	147
026 250 70	133
026 250 77	133
026 250 80	131
026 252 01	150
026 252 41	151
026 252 86	146
026 270 10	138
026 270 36	149
026 270 70	133
026 300 00	129
026 300 10	138
026 300 17	138
026 300 36	149
026 300 40	126
026 300 67	147
026 300 70	133
026 300 80	131
026 300 86	146
026 302 01	150
026 302 41	151
026 400 00	129
026 400 10	138
026 400 17	138
026 400 36	149

Item No	Page Seite
026 400 40	126
026 400 67	147
026 400 70	133
026 400 80	131
026 400 86	146
026 402 01	150
026 402 41	151
026 450 10	138
026 450 70	133
026 500 10	138
026 501 10	138
026 910 16	165
026 931 16	149
026 933 16	149
026 933 67	147
026 933 86	146
027 070 10	139
027 080 10	139
027 090 10	139
027 100 10	139
027 150 10	139
027 200 10	139
027 250 10	139
027 270 10	139
027 300 10	139
027 400 10	139
028 040 10	140
028 050 10	140
028 060 10	140
028 080 10	140
028 100 10	140
028 930 10	139
028 940 10	139
029 000 10	140
029 010 10	140
029 020 10	140
029 030 10	140
029 040 10	140
029 050 10	140
029 060 10	140
029 080 10	140
029 100 10	140
029 300 10	172
029 400 10	172
029 500 10	172
029 510 10	140
029 520 10	140
029 530 10	140
029 540 10	140
029 550 10	140

Item No	Page Seite
029 600 10	172
030 105 10	141
030 305 10	141
030 307 10	143
030 315 10	141
030 317 10	143
030 415 10	141
030 417 10	143
030 418 10	144
030 455 10	141
030 505 10	141
030 507 10	143
030 515 10	141
030 525 10	141
030 527 10	143
030 528 10	144
030 605 10	141
030 615 10	141
030 617 10	143
030 618 10	144
030 805 10	141
030 815 10	141
030 818 10	144
030 915 16	166
030 917 16	168
030 925 16	167
030 927 16	167
031 015 00	129
031 015 01	150
031 015 10	141
031 015 36	148
031 015 40	127
031 015 41	151
031 015 67	147
031 015 70	134
031 015 80	131
031 017 10	143
031 017 70	135
031 018 10	144
031 019 10	145
031 025 00	129
031 025 01	150
031 025 10	141
031 025 36	148
031 025 40	127
031 025 41	151
031 025 67	147
031 025 70	134
031 025 80	131
031 027 10	143

Item No	Page Seite
031 027 36	148
031 027 70	135
031 028 10	144
031 029 10	145
031 035 00	129
031 035 01	150
031 035 10	141
031 035 40	127
031 035 41	151
031 035 67	147
031 035 70	134
031 035 80	131
031 037 10	143
031 038 10	144
031 039 10	145
031 101 10	144
031 202 10	144
031 927 16	167
031 932 16	148
032 005 10	141
032 015 00	129
032 015 01	150
032 015 10	141
032 015 36	149
032 015 40	127
032 015 41	151
032 015 67	147
032 015 70	134
032 015 80	131
032 017 10	143
032 017 36	149
032 017 70	135
032 018 10	144
032 019 10	145
032 025 00	129
032 025 01	150
032 025 10	141
032 025 17	141
032 025 36	149
032 025 40	127
032 025 41	151
032 025 67	147
032 025 70	134
032 025 80	131
032 027 10	143
032 027 36	149
032 027 70	135
032 028 10	144
032 029 10	145
032 035 00	129

Item No	Page Seite
032 035 01	150
032 035 10	141
032 035 40	127
032 035 41	151
032 035 67	147
032 035 70	134
032 035 80	131
032 037 10	143
032 101 10	144
032 202 10	144
032 915 16	166
032 915 76	164
032 917 16	168
032 927 16	168
032 931 16	149
033 105 10	141
033 155 10	141
033 205 10	141
033 255 10	141
033 305 10	141
034 255 10	142
034 305 10	142
034 405 10	142
034 505 10	142
034 605 10	142
034 805 10	142
035 007 10	143
035 017 10	143
035 027 10	143
035 037 10	143
035 105 10	142
035 205 10	142
035 305 10	142
036 055 10	142
036 065 10	142
036 075 10	142
036 085 10	142
036 095 10	142
036 100 10	145
036 105 10	142
036 105 40	127
036 105 41	151
036 105 70	134
036 107 10	143
036 150 10	145
036 155 10	142
036 155 40	127
036 155 41	151
036 155 70	134
036 157 10	143

Item No	Page Seite
036 200 10	145
036 205 10	142
036 205 40	127
036 205 41	151
036 205 70	134
036 207 10	143
036 209 10	144
036 250 10	145
036 255 10	142
036 255 40	127
036 255 41	151
036 255 70	134
036 257 10	143
036 259 10	144
036 275 10	142
036 277 10	143
036 300 10	145
036 305 10	142
036 305 40	127
036 305 41	151
036 305 70	134
036 307 10	143
036 309 10	144
036 405 10	142
036 405 40	127
036 405 41	151
036 405 70	134
036 407 10	143
036 915 16	166
036 915 46	163
036 915 76	164
036 917 16	169
036 925 46	163
036 931 16	149
036 932 16	149
036 935 46	163
036 945 46	163
037 103 90	180
038 012 90	206
038 024 90	206
038 102 90	179
038 103 90	179
038 103 96	149
038 105 90	179
038 107 90	179
038 109 90	179
038 124 90	206
038 165 90	152
038 165 94	152
038 169 90	152

Item No	Page Seite
038 170 90	152
038 200 10	177
038 200 20	177
038 224 90	204
038 295 90	125
038 295 94	125
039 038 10	173
039 050 10	173
039 060 10	173
039 070 10	173
039 070 16	149
039 080 10	173
039 080 16	149
039 090 10	173
039 100 10	173
039 100 16	149
039 120 10	173
039 130 10	173
039 130 16	149
039 516 10	173
039 961 06	173
048 102 80	180
057 635 01	112
057 711 06	109
057 711 56	111
057 718 06	109
057 718 56	111
057 718 66	46
057 733 06	110
057 810 06	104
057 819 06	104
057 819 56	107
057 827 06	105
057 836 06	105
057 836 16	103
057 836 56	106
057 981 06	169
058 102 90	180
059 103 90	180
060 809 04	117
060 813 06	115
060 815 06	115
060 820 06	116
060 920 36	117
061 105 04	119
061 126 10	175
061 206 04	119
061 226 10	175
061 236 10	175
061 307 04	119

Item No	Page Seite
062 023 04	119
062 104 04	119
062 107 04	119
062 126 10	175
062 206 04	119
062 226 10	175
062 236 10	175
063 000 04	123
063 025 04	123
063 030 04	123
063 035 04	123
063 040 04	123
063 055 04	123
063 065 04	123
063 083 04	123
063 100 04	123
063 102 04	123
063 102 14	123
063 103 04	123
063 105 00	123
063 112 04	123
063 112 14	123
063 153 04	123
063 200 04	123
063 203 04	123
063 203 14	123
063 203 24	123
063 223 04	123
063 223 14	123
063 255 10	175
063 300 04	123
063 913 01	122
063 913 06	121
063 913 16	121
063 919 04	122
063 999 01	123
064 034 04	119
064 056 04	119
065 001 04	119
065 023 04	119
066 067 04	119
066 089 04	119
066 115 04	119
066 225 04	119
066 340 04	119
067 115 04	119
067 225 04	119
067 340 04	119
068 055 04	118
068 055 24	119

Item No	Page Seite
068 060 04	118
068 060 24	119
068 065 04	119
068 070 04	118
068 070 24	119
068 080 04	118
068 080 24	119
068 100 04	118
068 100 24	119
068 110 04	118
068 111 04	118
068 127 04	118
068 130 04	118
068 130 24	119
068 142 04	118
068 170 04	118
068 170 24	119
068 555 04	118
068 635 04	118
068 635 14	119
068 714 04	118
068 793 04	118
068 952 04	118
069 205 00	118
070 104 10	175
070 204 10	175
070 514 10	175
070 524 10	175
070 604 10	175
070 614 10	175
070 804 10	175
070 814 10	175
071 010 10	175
071 020 10	175
071 030 10	175
071 042 10	175
072 010 10	176
072 020 10	176
072 030 10	176
072 042 10	176
074 100 10	176
074 300 10	176
074 400 10	176
074 500 10	176
074 600 10	176
074 800 10	176
076 253 10	176
076 273 10	176
076 303 10	176
076 403 10	176

Item No	Page Seite
076 453 10	176
076 503 10	176
076 553 10	176
078 005 10	176
078 006 10	176
078 008 10	176
078 010 10	176
078 012 10	176
078 050 10	176
078 060 10	176
078 080 10	176
078 100 10	176
078 120 10	176
079 080 10	172
079 100 10	172
081 020 10	177
081 025 10	177
082 020 10	177
082 020 20	177
082 025 10	177
082 225 10	177
086 020 10	177
086 025 10	177
086 200 10	177
086 250 10	177
096 040 10	113
096 045 10	113
096 050 10	113
096 055 10	113
096 055 20	107
096 060 10	113
096 060 20	107
096 070 10	113
096 070 20	107
096 080 10	113
096 080 20	107
096 090 10	113
096 100 10	113
096 100 20	107
096 110 10	113
096 120 10	113
096 130 10	113
096 130 20	107
096 140 10	113
096 200 10	113
096 210 10	113
096 220 10	113
096 230 10	113
096 240 10	113
096 250 10	113

Item No	Page Seite
096 260 10	113
096 270 10	113
096 280 10	113
096 290 10	113
096 300 10	113
096 310 10	113
096 320 10	113
097 000 10	113
097 011 10	181
097 013 10	181
097 018 10	181
097 019 10	113
097 020 10	181
097 050 10	112
097 070 10	181
097 100 10	112
097 150 14	119
100 001 06	79
100 002 06	79
100 003 06	79
100 006 00	79
100 032 04	80
100 043 04	80
100 043 94	81
100 060 00	79
100 353 04	80
100 353 94	81
100 554 04	80
100 554 94	81
100 991 16	77
100 992 16	77
100 993 16	78
101 001 04	80
101 102 04	80
101 102 94	81
101 203 04	80
101 203 94	81
102 001 04	80
102 102 04	80
102 102 94	81
102 203 04	80
102 203 94	81
104 015 04	80
104 020 04	80
104 025 04	80
104 030 04	80
104 040 04	80
106 102 04	80
106 203 04	80
106 203 94	81

Item No	Page Seite
107 102 04	80
107 102 94	81
107 203 04	80
107 203 94	81
108 061 04	80
108 071 04	80
108 083 04	80
108 093 04	80
108 103 04	80
108 153 04	80
108 203 04	80
108 253 04	80
109 061 04	80
109 071 04	80
109 083 04	80
109 093 04	80
109 103 04	80
109 153 04	80
109 203 04	80
109 253 04	80
118 125 04	80
197 170 04	79
200 022 90	39
200 032 90	39
200 043 90	39
200 054 90	39
200 086 90	39
200 107 90	39
200 112 96	42
200 114 96	43
200 353 90	39
200 550 90	39
200 554 90	39
200 650 90	39
200 654 90	39
200 655 90	39
200 951 98	40
200 971 97	41
200 972 97	42
200 972 98	40
200 973 98	41
200 994 90	199
200 997 90	200
201 001 90	39
201 020 90	39
201 102 90	39
201 203 90	39
201 305 90	39
202 001 90	39
202 020 90	39

Item No	Page Seite
202 102 90	39
202 203 90	39
202 305 90	39
206 055 90	37
206 065 90	37
206 080 90	37
206 100 90	37
206 120 90	37
206 951 98	37
206 992 90	199
208 061 90	40
208 071 90	40
208 083 90	40
208 093 90	40
208 103 90	40
208 153 90	40
208 203 90	40
208 253 90	40
208 273 90	40
208 303 90	40
208 404 90	40
208 971 98	41
208 991 90	200
216 203 90	37
216 305 90	37
226 203 90	37
226 305 90	37
240 033 50	83
240 035 50	83
240 037 50	83
240 043 50	83
240 045 50	83
240 047 50	83
240 151 50	83
240 201 50	83
240 252 50	83
240 255 50	83
240 257 50	83
240 333 50	83
240 353 50	83
240 355 50	83
240 358 50	83
240 951 50	202
240 961 50	201
240 961 56	85
240 990 50	201
241 001 50	83
241 102 50	83
242 000 50	83
242 001 50	83

Item No	Page Seite
242 009 50	83
242 102 50	83
242 105 50	83
245 961 06	85
246 151 50	84
246 201 50	84
246 252 50	84
246 302 50	84
248 051 50	84
248 061 50	84
248 071 50	84
248 081 50	84
248 091 50	84
248 103 50	84
248 108 50	84
248 153 50	84
248 158 50	84
248 208 50	84
248 961 56	85
249 300 50	84
249 350 50	84
249 400 50	84
249 450 50	84
249 500 50	84
249 550 50	84
249 961 56	85
250 033 80	87
250 035 80	87
250 151 80	87
250 201 80	87
250 252 80	87
250 961 80	203
250 961 86	87
252 001 80	87
252 009 80	87
252 102 80	87
280 153 14	86
280 235 14	86
280 245 14	86
280 907 06	86
280 907 16	86
280 907 26	86
280 961 10	202
281 010 14	86
282 000 14	86
282 001 14	86
284 134 14	86
284 152 14	86
284 253 14	86
286 615 14	86

Item No	Page Seite
286 710 14	86
286 890 14	86
303 035 80	91
303 045 80	91
303 055 80	91
303 065 80	91
303 085 80	91
303 087 80	91
303 107 80	91
303 203 80	91
303 253 80	91
304 064 80	91
304 068 80	91
304 078 80	91
304 084 80	91
304 088 80	91
304 089 80	91
304 098 80	91
304 104 80	91
304 108 80	91
304 109 80	91
304 118 80	91
304 128 80	91
304 134 80	91
304 138 80	91
304 139 80	91
304 178 80	91
304 558 80	91
308 103 80	92
308 153 80	92
308 204 80	92
308 207 80	92
308 254 80	92
308 257 80	92
308 277 80	92
308 307 80	92
308 407 80	92
308 455 80	92
313 020 00	93
313 025 00	93
313 030 00	93
313 035 00	93
313 040 00	93
313 045 00	93
313 050 00	93
313 060 00	93
313 070 00	93
313 080 00	93
313 090 00	93
313 100 00	93

Item No	Page Seite
313 120 00	93
313 140 00	93
326 965 10	47
326 965 11	47
335 035 90	45
335 045 90	45
335 055 90	45
335 065 90	45
335 080 90	45
335 100 90	45
335 120 90	45
335 951 98	45
335 952 98	46
335 971 98	46
335 991 90	203
336 102 90	45
336 203 90	45
336 305 90	45
337 102 90	45
337 203 90	45
337 305 90	45
338 125 80	92
340 040 00	93
340 040 04	93
340 055 00	93
340 055 04	93
340 080 00	93
340 080 04	93
341 120 00	93
341 120 04	93
341 340 00	93
341 340 04	93
342 120 00	93
342 120 04	93
342 340 00	93
342 340 04	93
343 260 00	93
343 260 04	93
345 006 01	100
345 007 01	100
345 015 00	98
345 020 00	98
345 025 00	98
345 030 00	98
345 040 00	98
345 050 00	98
345 060 00	98
345 080 00	98
345 100 00	98
345 120 00	98

Item No	Page Seite
345 140 00	98
345 170 00	98
348 006 00	96
348 007 00	96
348 008 00	96
348 009 00	96
348 010 00	96
348 015 00	96
348 020 00	96
348 025 00	96
348 027 00	96
348 030 00	96
348 040 00	96
348 045 00	96
348 050 00	96
348 055 00	96
348 060 00	96
348 080 01	97
348 088 01	97
348 105 50	95
348 106 50	95
348 107 50	95
348 108 50	95
348 109 50	95
348 110 50	95
348 115 50	95
348 120 50	95
348 888 01	96
348 907 50	95
349 105 50	95
349 106 50	95
349 107 50	95
349 108 50	95
349 109 50	95
349 110 50	95
349 115 50	95
349 120 50	95
349 907 50	96
355 009 01	101
355 015 00	98
355 020 00	98
355 025 00	98
355 030 00	98
355 040 00	98
355 050 00	98
355 060 00	98
355 080 00	98
355 100 00	98
355 150 01	101
361 300 00	70

Item No	Page Seite
361 300 01	70
361 350 00	70
361 350 01	70
361 400 00	69
361 400 01	69
361 600 00	70
361 600 04	70
361 700 00	70
361 700 04	70
363 100 05	70
365 009 01	99
365 015 00	99
365 020 00	99
365 025 00	99
365 030 00	99
365 040 00	99
365 050 00	99
365 060 00	99
365 080 00	99
365 100 00	99
373 108 05	89
373 208 05	89
374 004 05	89
374 204 05	89
375 130 01	101
376 041 05	89
376 044 05	89
376 912 00	193
389 800 01	112
389 900 00	118
391 010 00	209
391 011 00	194
391 014 00	195
391 015 00	208
391 020 00	201
391 023 00	201
391 023 50	202
391 024 00	209
391 026 00	209
391 043 00	209
391 058 00	208
391 091 00	191
391 818 90	204
397 127 80	92
397 635 80	92
397 952 80	92
400 022 10	10
400 032 10	10
400 043 10	10
400 055 10	10

Item No	Page <i>Seite</i>
400 063 10	10
400 065 10	10
400 067 10	10
400 086 10	10
400 106 36	15
400 107 10	10
400 206 36	15
400 353 10	10
400 550 10	13
400 554 10	10
400 555 10	10
400 653 10	10
400 655 10	10
400 657 10	10
400 861 18	19
400 905 10	192
400 907 10	192
400 910 13	14
400 910 43	14
400 917 43	14
400 931 18	17
400 951 18	16
400 953 18	16
400 961 18	16
400 971 18	15
400 991 10	194
401 102 10	10
401 203 10	10
401 305 10	10
401 951 48	17
402 020 10	13
402 102 10	11
402 203 10	11
402 205 10	11
402 207 10	11
402 305 10	11
402 951 48	17
404 000 40	11
404 100 40	11
404 200 40	11
404 300 40	11
404 931 48	17
407 103 40	11
407 153 40	11
407 203 40	11
407 253 40	11
408 071 40	11
408 083 40	11
408 093 40	11
408 103 40	11

Item No	Page <i>Seite</i>
408 153 40	11
408 203 40	11
408 253 40	11
408 273 40	11
408 303 40	11
408 404 40	11
408 931 48	18
408 961 48	18
408 962 48	18
410 042 40	8
410 085 40	8
410 105 40	8
410 127 40	8
410 553 40	8
410 654 40	8
410 961 48	8
410 962 48	9
410 963 48	9
410 991 40	194
411 102 40	8
411 203 40	8
411 305 40	8
412 102 40	8
412 203 40	8
412 305 40	8
412 405 40	8
413 025 90	53
413 030 90	53
413 035 90	53
413 038 90	53
413 040 90	53
413 045 90	53
413 055 90	53
413 065 90	53
413 080 90	53
413 106 36	56
413 807 36	61
413 811 04	188
413 841 98	60
413 851 98	61
413 852 98	60
413 881 90	62
413 905 90	192
413 907 90	192
413 910 93	62
413 911 04	188
413 930 90	59
413 931 94	55
413 935 90	59
413 938 90	59

Item No	Page <i>Seite</i>
413 940 90	59
413 945 90	59
413 955 90	59
413 961 98	55
413 963 98	55
413 965 90	59
413 985 17	189
413 991 90	195
413 995 04	189
414 001 90	53
414 102 90	53
414 192 90	59
414 203 90	53
414 293 90	59
414 304 90	53
414 910 93	56
415 102 90	53
415 192 90	59
415 203 90	53
415 293 90	59
415 304 90	53
416 102 90	54
416 192 90	59
416 203 90	54
416 293 90	59
417 102 90	54
417 192 90	59
417 203 90	54
417 293 90	59
417 921 91	54
418 103 90	54
418 109 90	60
418 153 90	54
418 159 90	60
418 203 90	54
418 209 90	60
418 253 90	54
418 259 90	60
418 303 90	54
419 055 30	57
419 060 30	57
419 070 30	57
419 080 30	57
419 100 30	57
419 100 90	54
419 106 36	57
419 130 30	57
419 190 90	60
419 200 90	54
419 290 90	60

Item No	Page Seite
428 055 30	12
428 060 30	12
428 070 30	12
428 080 30	12
428 100 30	12
428 106 36	19
428 130 30	12
429 050 40	12
429 060 40	12
429 070 40	12
429 080 40	12
429 100 40	12
429 635 40	12
438 025 40	112
438 026 40	13
438 125 40	13
490 041 10	47
493 063 10	47
494 003 30	47
497 110 40	13
497 200 00	13
497 635 41	107
498 063 10	47
500 022 10	25
500 032 10	25
500 032 30	28
500 037 30	28
500 043 10	25
500 043 30	28
500 047 10	25
500 047 30	28
500 049 10	25
500 086 10	25
500 088 10	25
500 096 10	25
500 107 10	25
500 111 16	35
500 112 16	35
500 353 10	25
500 353 30	28
500 358 30	28
500 504 10	25
500 505 10	25
500 550 10	26
500 554 10	25
500 556 10	25
500 557 10	25
500 559 10	25
500 610 10	25
500 655 10	25

Item No	Page Seite
500 656 10	25
500 657 10	25
500 924 00	34
500 931 14	33
500 933 34	32
500 934 14	33
500 951 18	33
500 961 17	31
500 963 17	31
500 971 18	34
500 971 37	32
500 991 30	198
500 992 10	196
500 994 10	196
501 001 10	25
501 010 10	26
501 020 10	26
501 102 10	25
501 102 30	28
501 203 10	25
501 203 30	28
501 207 10	25
501 207 30	28
501 209 10	25
501 305 10	25
502 001 10	25
502 010 10	26
502 020 10	26
502 102 10	25
502 102 30	28
502 107 10	25
502 107 30	28
502 203 10	25
502 203 30	28
502 205 10	25
502 207 10	25
502 207 30	28
502 209 10	25
502 210 10	25
502 305 10	25
507 103 40	26
507 153 40	26
507 203 40	26
507 253 40	26
507 273 40	26
507 303 40	26
507 404 40	26
507 961 48	34
508 051 40	27
508 061 40	27

Item No	Page Seite
508 071 40	27
508 083 40	27
508 093 40	27
508 103 30	28
508 103 40	27
508 153 30	28
508 153 40	27
508 203 30	28
508 203 40	27
508 253 30	28
508 253 40	27
508 273 40	27
508 303 40	27
508 404 40	27
508 454 40	27
508 912 40	197
508 931 34	33
508 961 47	31
508 971 47	32
509 061 40	27
509 071 40	27
509 083 40	27
509 093 40	27
509 103 40	27
509 153 40	27
509 203 40	27
509 253 40	27
509 273 40	27
509 303 40	27
509 404 40	27
511 405 40	25
513 025 90	63
513 030 90	63
513 035 90	63
513 040 90	63
513 045 90	63
513 055 90	63
513 065 90	63
513 080 90	63
513 931 14	65
513 951 98	65
513 956 98	65
513 961 97	64
513 961 98	64
513 991 90	197
514 001 90	63
514 102 90	63
514 203 90	63
514 304 90	63
515 102 90	63

Item No	Page Seite
515 203 90	63
515 304 90	63
518 125 90	63
520 045 10	29
520 055 10	29
522 105 10	29
522 205 10	29
527 202 40	30
527 253 40	30
527 303 40	30
527 403 40	30
527 503 40	30
527 604 40	30
527 805 40	30
528 040 40	30
528 050 40	30
528 055 40	30
528 058 40	30
528 060 40	30
528 068 40	30
528 070 40	30
528 078 40	30
528 080 40	30
528 090 40	30
528 100 40	30
528 110 40	30
528 120 40	30
528 130 40	30
528 140 40	30
538 100 40	29
538 125 40	30
550 045 40	21
550 055 40	21

Item No	Page Seite
550 065 40	21
550 080 40	21
550 090 40	21
550 100 40	21
550 120 40	21
550 932 44	23
550 951 48	22
550 952 48	22
550 961 47	22
550 993 40	195
551 102 40	21
551 203 40	21
551 305 40	21
552 102 40	21
552 203 40	21
552 305 40	21
580 001 00	187
580 016 40	186
580 018 40	186
581 016 40	186
581 018 40	186
581 020 40	187
582 017 40	186
582 225 40	186
583 016 40	187
583 999 11	71
584 016 40	187
584 018 11	71
586 018 40	187
590 016 40	184
590 018 40	184
591 014 40	184
591 016 40	184

Item No	Page Seite
591 018 40	184
591 020 40	185
591 118 40	184
592 020 40	184
592 220 40	184
597 200 00	30
600 110 96	68
613 025 90	66
613 030 90	66
613 035 90	66
613 040 90	66
613 055 90	66
613 065 90	66
613 080 90	66
613 090 90	66
613 100 90	66
613 962 98	68
613 973 97	67
613 974 97	67
613 992 90	198
614 001 90	66
614 102 90	66
614 203 90	66
614 304 90	66
615 001 90	66
615 102 90	66
615 203 90	66
615 304 90	66
894 020 40	185
895 025 40	185
895 250 40	185

Verkaufs- und Lieferbedingungen

Nachstehende Lieferbedingungen gelten durch Auftragserteilung als vereinbart. Hier von abweichende Vereinbarungen werden erst durch unsere schriftliche Bestätigung gültig. Sie heben den übrigen Teil der Verkaufs- und Lieferungsbedingungen nicht auf.

1. Angebot und Vertragsabschluss

Unsere Angebote sind freibleibend, Verträge und sonstige Vereinbarungen werden erst durch unsere schriftliche Bestätigung oder durch unsere Lieferung/Leistung verbindlich. Sämtliche Vereinbarungen zwischen uns und unseren Kunden sind bei Vertragsabschluss schriftlich niederzulegen. Bei oder nach Vertragsabschluss getroffene Vereinbarungen zwischen unseren Mitarbeitern oder Vertretern und unseren Kunden bedürfen zu ihrer Gültigkeit unserer schriftlichen Bestätigung; die Vertretungsmacht unserer Mitarbeiter und Vertreter ist insoweit eingeschränkt.

Ergänzungen, Änderungen oder Nebenabreden bedürfen ebenfalls der Schriftform. Dies gilt auch für die Aufhebung des Schriftformerfordernisses.

2. Lieferverpflichtung

Voraussetzung für die Lieferpflicht ist die unbedingte Kreditwürdigkeit des Kunden. Werden die Zahlungsbedingungen nicht eingehalten oder werden Umstände bekannt, die die Kreditwürdigkeit des Kunden ernsthaft in Frage stellen oder wird ein Scheck nicht eingelöst, so werden sämtliche offen stehende Forderungen fällig. Nach fruchtlosem Ablauf einer von uns gesetzten Nachfrist, auch ohne Kündigungsandrohung, sind wir berechtigt, den Vertrag schriftlich zu kündigen und die Lieferungen einzustellen sowie alle bisher erbrachten Lieferungen abzubrechen.

Teillieferungen sind zulässig.

Bei Sonderanfertigungen behalten wir uns eine Mehr- oder Minderlieferung von 10 % vor, auch für den Fall, dass Teillieferungen bereits erfolgt sind oder noch erfolgen. Bestellungen auf Abruf sind, wenn nichts anderes schriftlich vereinbart ist, spätestens innerhalb von einem viertel Jahr nach Ablauf der Vertragsfrist abzunehmen, ohne dass wir die Abnahme unter Fristsetzung annehmen. Nach Ablauf dieser 3 Monate sind wir berechtigt, nach unserer Wahl entweder die Ware in Rechnung zu stellen oder den Auftrag zu streichen. Störungen und Ereignisse höherer Gewalt berechtigen uns, die eingegangene Lieferfrist für die Dauer der Betriebsverhinderung und einer angemessenen Anlaufzeit zu verlängern. Unter Umständen können auch unsere Lieferverpflichtungen ganz oder teilweise aufgehoben werden. Dies gilt auch, wenn uns die Lieferung unmöglich geworden ist, ohne dass wir dieses zu vertreten haben.

Der Kunde kann von uns dann die Erklärung verlangen, ob wir zurücktreten oder innerhalb angemessener Frist liefern. Die Geltendmachung von Ersatzansprüchen in irgendeiner Art infolge verspäteter Lieferung ist auf einen Maximalwert von 5 % des Auftragswertes beschränkt.

3. Lieferzeit

Die Lieferzeit ist eingehalten, wenn bis zu ihrem Ablauf die Versandbereitschaft mitgeteilt ist, oder der Liefergegenstand das Werk verlassen hat. Der in der Auftragsbestätigung genannte Termin ist freibleibend, wenn nicht eine gesonderte schriftliche Lieferzusicherung erfolgt ist.

4. Preise

Unsere Preise beruhen auf den zum Zeitpunkt der Auftragsannahme gültigen Kalkulationsunterlagen. Lieferungen, die später als 4 Monate nach Vertragsabschluss erbracht werden, berechtigen uns, z.B. bei Lohn- und/oder Materialpreiserhöhungen, eine Anpassung der Preise bis zu maximal 5 % vorzunehmen.

5. Transport

Die Wahl des Transportweges und der Transportmittel erfolgt nach bestem Ermessen ohne Haftung für den billigsten Weg. Sofern uns besondere Vorschriften gegeben werden, erfolgt der Versand entsprechend. Das Transportrisiko trägt in jedem Fall der Empfänger; auch dann, wenn die Lieferung frei Empfangsort oder FOB eines Schiffes vereinbart wird.

Mit Verlassen des Werkes wird die Ware als bedingungsgemäß geliefert betrachtet, auch wenn sie unmittelbar an Dritte gesandt wird.

6. Eigentumsvorbehalt

Die gelieferte Ware bleibt bis zur Erfüllung aller uns aus der gegenseitigen Geschäftsbeziehung zustehenden Ansprüchen unser Eigentum. Der Kunde darf die in unserem Eigentum stehende Ware weder an Dritte verpfänden noch zur Sicherheit übereignen. Bei Pfändung der in unserem Eigentum stehenden Ware ist der Kunde verpflichtet, uns sofort zu benachrichtigen und zwar unter Vorlegung der Pfändungspapiere und einer eidesstattlichen Versicherung, aus der hervorgeht, dass die Ware unser Eigentum ist. Die Kosten für eine evtl. notwendig werdende Intervention trägt der Kunde.

Der Kunde ist berechtigt, die gelieferte Ware im ordnungsgemäßen Geschäftsgang weiter zu veräußern. Im Falle der Weiterveräußerung tritt an die Stelle der gelieferten Ware der Anspruch des Kunden an seinen Abnehmer, der bis zur Höhe unserer gesamten Forderungen schon jetzt als an uns abgetreten gilt. Der Kunde ist zur Einziehung der Forderung bis auf Widerruf berechtigt. Auf Verlangen ist der Kunde verpflichtet, die Abtretung den Drittschuldnern mitzuteilen und uns die zur Geltendmachung unserer Rechte erforderlichen Auskünfte zu geben und Unterlagen auszuhandigen. Die Abtretung der Forderungen wird von selbst hinfällig, sobald der Kunde die Kaufpreisschuld bzw. alle Verbindlichkeiten aus laufender Geschäftsverbindung beglichen hat. Ist der Eigentumsvorbehalt oder die Abtretung nach dem Recht, in dessen Bereich sich die Ware befindet, nicht wirksam, so gilt die dem Eigentumsvorbehalt und der Abtretung in diesem Bereich entsprechende Sicherung als vereinbart. Ist zur Entstehung solcher Rechte die Mitwirkung des Kunden erforderlich, so ist er auf unsere Anforderung hin verpflichtet, alle Maßnahmen zu treffen, die zur Begründung und Erhaltung solcher Rechte erforderlich sind.

7. Zahlung

Für die Zahlung sind unsere jeweiligen Bedingungen maßgebend. Abzüge jeder Art ohne die entsprechende Vereinbarung sind unzulässig. Eingereichte Schecks gelten erst nach vollständiger Einlösung als Zahlung. Bei Überschreitung der Zahlungsfrist werden vom Fälligkeitstag an unter Vorbehalt der Geltendmachung weiteren Verzugschadens Verzugszinsen berechnet. Der berechnete Zinssatz beträgt 9 %. Gerät der Kunde mit seiner Zahlung in Verzug, so steht uns das Recht zu, sofortige Zahlung aller offenen, auch noch nicht fälligen Forderungen oder eine Herausgabe der gelieferten Ware bis zur vollständigen Begleichung unserer Forderung zu verlangen.

8. Gewährleistung

Beanstandungen über Menge und Qualität können nur angenommen und geprüft werden, wenn sie schriftlich innerhalb von 14 Tagen nach Eingang der Ware am Bestimmungsort vorgenommen werden. Waren, die wir als fehlerhaft anerkennen, nehmen wir zurück und liefern dafür Ersatz. Weiter Ansprüche des Kunden können wir nicht anerkennen.

9. Erfüllungsort und Gerichtsstand

Erfüllungsort ist: 35279 Neustadt Kreis Marburg, Gerichtsstand - ohne Rücksicht auf die Höhe des Objektes das Landgericht Marburg/Lahn. Maßgebend ist das deutsche Recht.

10. Salvatorische Klausel

Sollten Bestimmungen dieses Vertrages unwirksam, unvollständig oder undurchführbar sein, so bleiben die übrigen Bestimmungen unverändert gültig. In diesem Falle soll eine Regelung gefunden werden, die im Rahmen des gesetzlich Zulässigen wirtschaftlich dem am nächsten kommt, was die Parteien gewollt haben oder gewollt haben würden, wenn sie diesen Punkt bedacht hätten.

Preisliste ist gültig ab 01.03.2017

Terms of Sale and Delivery

The following terms of delivery shall be considered as agreed upon at order placement. Deviating agreements shall only obtain validity by our written confirmation. The deviating agreements shall not rescind the remaining terms of sale and delivery.

1. Quotation and Conclusion of Contract

Our quotations shall be without engagement. Contracts and other agreements shall only become binding through our written confirmation or our performance. All agreements between us and our customers shall be concluded in writing at conclusion of contract.

Agreements made between our employees or representatives and our customers during or subsequent to contract conclusion shall only become valid with our written confirmation; the power of attorney held by our employees or representatives shall be limited in this respect. Supplements, modifications or additional agreements also require the written form. This shall also apply to rescinding the requirement of the written form.

2. Delivery Commitment

The customer's unconditional creditworthiness shall be a prerequisite for delivery commitment. Should the terms of payment not be adhered to or circumstances become known which seriously put the customer's creditworthiness into question or if a cheque is not honoured, all receivables become due. On failure of payment within an adequate period of grace set by us, even if devoid of a threat of termination, we shall be entitled to withdraw from the contract in writing and discontinue deliveries and cease all previously performed deliveries. Partial deliveries are admissible. We reserve the right to 10 % over or short delivery for custom-made products, this also applies in case partial deliveries have already been made or are yet to be made. If nothing else has been agreed upon in writing, orders on call must be purchased within three months of expiry of the contractual deadline, without us having to send a reminder containing an explicit purchase deadline. After these three months have expired, we shall optionally be entitled to either invoice the goods or cancel the order. Disruptions and force majeure incidents entitle us to extend the agreed delivery period for the duration of the operative hindrance and a reasonable start-up period. As the case may be our delivery commitments may also be revoked partially or completely. This also applies if it has become impossible for us to deliver at no fault of ours. The customer may then demand our statement as to whether we want to withdraw from delivery or deliver within a reasonable deadline. Compensation claims of any kind resulting from late delivery are limited to 5 % of the order value.

3. Delivery Period

The delivery period shall be deemed as adhered to if readiness for shipment has been notified or the object of delivery has left the manufacturing company before expiry of the delivery period. The deadline mentioned in the order confirmation is without engagement unless a separate written delivery confirmation has been issued.

4. Prices

Our prices are based on the calculation documents applicable at the time of order acceptance. Deliveries which are performed later than four months after conclusion of contract entitle us to adjust the prices by maximally 5%, e.g. in case of wage increases or increases in material prices.

5. Transport

The choice of the route or means of transport is made according to best judgement with no liability for the cheapest route. As far as particular specifications have been provided to us, shipping shall proceed accordingly. The risk of transport shall in any case be borne by the receiver, even if delivery 'free at destination' or FOB a ship has been agreed. On departure from the manufacturing company the goods shall be regarded as delivered according to agreement, even if they are delivered directly to third parties.

6. Reservation of Title

We reserve the title for the delivered goods until all our rightful claims resulting from our mutual business relationship have been fulfilled. The customer may neither pledge the goods which are in our property, nor convey them as collateral to third parties. On the seizure of goods which are our property the customer shall be committed to notify us of this immediately and furthermore present us with the seizure documents as well as an affidavit showing that the goods are our property. The expenses for a possibly required intervention shall be borne by the customer. The customer shall be entitled to resell the delivered goods in the regular course of business. In case of a resale, the customer's claim towards the sub-purchaser, which is already considered as assigned to us up to the amount of our total receivables, shall replace the delivered goods. The customer is entitled to collect the receivables until such title is revoked. Upon request the customer is committed to notify the garnishees of such assignment and disclose to us any information and hand out any documents to us required in order to protect our rights. The assignment of the receivables shall lapse as soon as the customer has honoured the debt resulting from the purchase price and/or all debt resulting from the current business relationship. Should reservation of title or assignment be invalid according to the jurisdiction in the area where the goods are located, the collateral which applies in that area ensuring reservation of title and assignment shall be considered agreed. Should the customer's cooperation be necessary for the origination of such rights, customer shall be committed to take all measures required in order to constitute and preserve such rights.

7. Payment

Our respective terms are applicable to payment. Deductions of any kind without a respective agreement are prohibited. Cheques that have been handed in shall only be considered as payment after their full encashment. On exceeding the payment deadline default interests shall be charged as of the due date, subject to any claim for further default damages. The charged default interest rate is 9 %. In the event that the customer enters into default with their payment, we have the right to demand immediate payment of all arrears including those which have not yet entered into default, or release of the delivered goods until complete payment of our receivables.

8. Warranty

Complaints concerning quantity and quality can only be accepted and examined if made in writing within 14 days after receipt of the goods at the place of destination. Goods which we acknowledge as being defective will be taken back and replaced. Any additional claims by the customer shall not be recognised by us.

9. Place of Performance and Jurisdiction, Language

Place of performance shall be 35279 Neustadt Kreis Marburg, Federal Republic of Germany. Place of Jurisdiction - notwithstanding the amount of the subject - shall be the Marburg / Lahn district court. German Law shall prevail. Contract language shall be German. In case of dissent the German version shall prevail.

10. Severability Clause

Should any provision of this agreement be or become invalid, ineffective or unenforceable, the validity, effectiveness and enforceability of the remaining provisions shall not be affected thereby. In such event a provision must be found that comes as closest to the legally permitted economic intent and purpose of what the parties had or would have intended had they considered the aspect.

6/09

This price-list is valid with effect from 01.03.2017

