

Model No. GA9063R 230MM ANGLE GRINDER

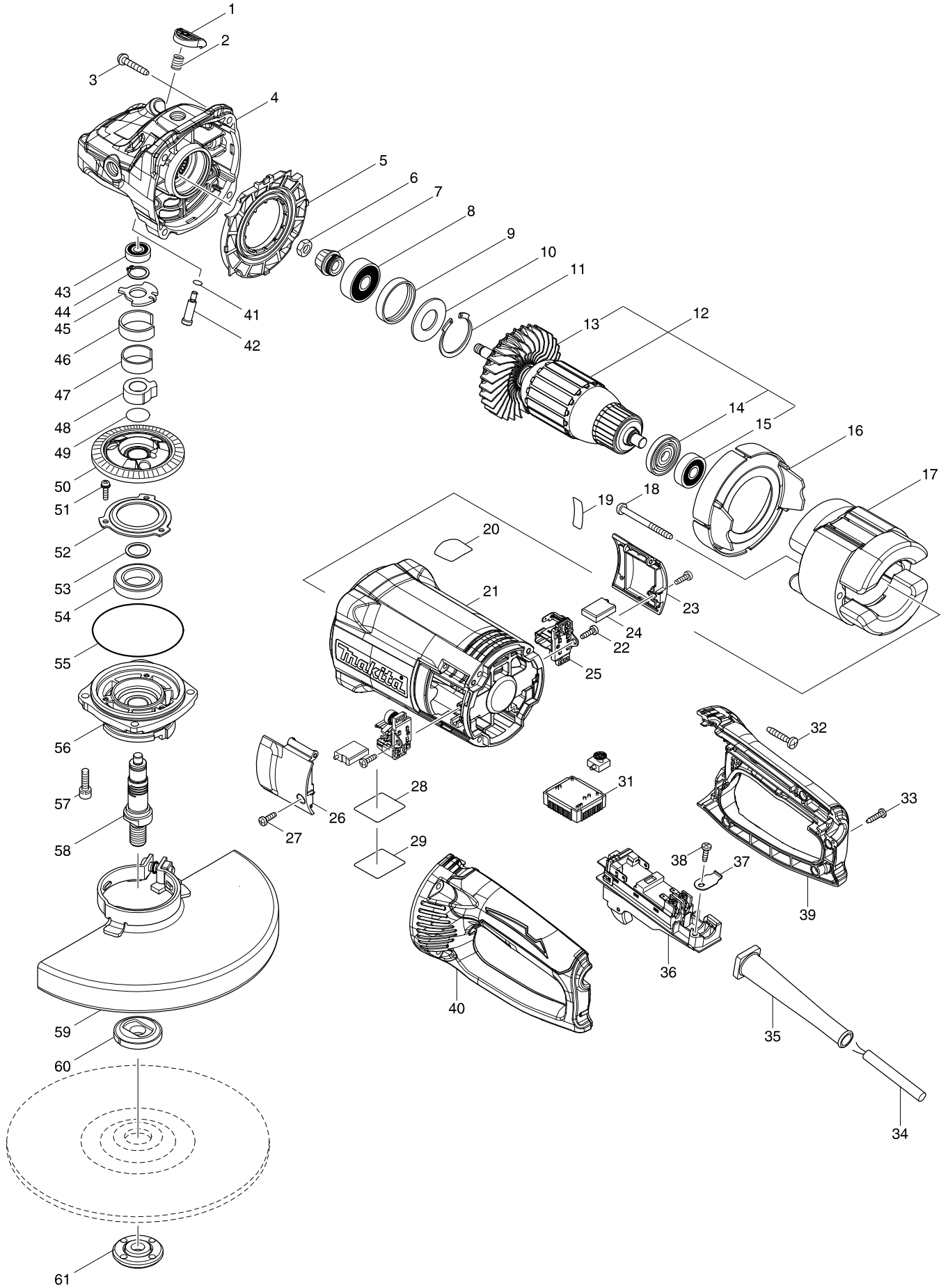

Model No. GA9063R 230MM ANGLE GRINDER

Item	Parts No.	Description	I/C	QTY	N/O	Opt. 1	Opt. 2	NOTE
001	456247-8	PIN CAP		1				
002	234391-9	COMPRESSION SPRING 8		1				
003	251489-7	TAPPING SCREW 5X30		4				
004	143485-8	GEAR HOUSING COMPLETE		1				
C10	263002-9	RUBBER PIN 4		1	100			
005	456238-9	DIFFUSER		1				
006	252194-9	HEX. NUT M8		1	100			
007	227652-4	SPIRAL BEVEL GEAR 13		1				
008	211132-0	BALL BEARING 6301DDW		1	100			
009	262085-6	RUBBER RING 38		1	100			
010	267299-2	FLAT WASHER 20		1	100			
011	962211-4	RETAINING RING R-42		1	100			
D10		INC. 13-15						
012A	513446-6	ARMATURE ASS'Y 115V		1				
012B	513449-0	ARMATURE ASS'Y 240V		1				
013	240161-6	FAN 86		1				
014	681630-2	INSULATION WASHER		1	100			
015	211087-9	BALL BEARING 6200DDW		1	100			
016	456239-7	BAFFLE PLATE		1				
017A	621776-2	FIELD 115V		1				
017B	621779-6	FIELD 240V		1				
018	266044-2	TAPPING SCREW 5X60		2	100			
019	853D19-0	GA9063R SERIAL NO. LABEL		1				
020	898443-6	SJS2 MARK LABEL		1	100			
021	456240-2	MOTOR HOUSING		1				
022	266192-7	TAPPING SCREW 4X14		2	100			
023	456246-0	BRUSH HOLDER COVER R		1				
024	197129-2	CARBON BRUSH CB-218		1				
025	643715-2	BRUSH HOLDER		2				
026	456245-2	BRUSH HOLDER COVER L		1				
027	266192-7	TAPPING SCREW 4X14		2	100			
028	853D17-4	GA9063R NAME PLATE		1				
029	809R72-8	CLEAR LABEL		1				
031A	620587-2	CONTROLLER		1				
031B	620588-0	CONTROLLER		1				
032	251489-7	TAPPING SCREW 5X30		4				
033	265995-6	TAPPING SCREW 4X18		4	100			
034A	665550-8	POWER SUPPLY CORD 2.5-2-2.5		1	100			
034B	692607-2	POWER SUPPLY CORD 1.5-2-2.5		1				
035A	682581-2	CORD GUARD		1				
035B	682573-1	CORD GUARD 10		1	100			
036	632F78-7	SWITCH UNIT		1				
037A	687678-2	STRAIN RELIEF		1	100			
037B	687169-3	STRAIN RELIEF		1	100			
038	266192-7	TAPPING SCREW 4X14		1	100			
039	183G25-2	HANDLE SET		1				
D10		INC. 40						
040	183G25-2	HANDLE SET		1				

